

Customizable,
High Quality, Heavy Duty,
Industrial-Grade Actuators

INDUSTRIAL MOTION

TiMOTION ELECTRONIC LINEAR ACTUATORS – MOTION TECHNOLOGY THAT HELPS PROVIDE A CLEANER, BETTER FUTURE

Many industrial applications require heavy-duty automation on a large scale — especially for agricultural, construction, mining, ventilation, and process control machinery, among others. The technology is out there, and it's only getting better. Equipment manufacturers are increasingly turning to electric linear actuators as a cost-efficient and reliable alternative to previous industry standards, such as hydraulic and pneumatic motion systems. TiMOTION's Industrial Motion product line is shown within this catalog, as well as additional information about what we offer and the full benefits of our linear actuator technology.

Features and Benefits of TiMOTION Actuation Systems for Industrial Applications

- Five year mechanical warranty
- Aluminum and steel construction
- Acme and ball screw drive
- Customization
- Clutch or internal limit switches
- Multiple feedback options
- Easy installation
- Excellent engineering support
- IP69K protection available
- Heavy duty construction
- Low maintenance
- Wide speed range

JP3

series



TiMOTION's JP3 series inline linear actuator was designed for low load industrial applications where up to IP69K dust and liquid ingress protection is necessary. It is best suited for applications with visual or compact installation dimension requirements. Hall sensors are optional for the JP3 which allow for synchronization and position feedback.

Load and Speed

	CODE	Load (N)		Self Locking Force (N)	Typical Current (A)		Typical Speed (mm/s)	
		Push	Pull		No Load 24V DC	With Load 24V DC	No Load 24V DC	With Load 24V DC
Motor Speed (5600RPM)	B	2000	2000	1000	1.0	3.0	7.0	3.5
	C	1500	1500	500	1.0	3.0	10.0	6.5
	D	1000	1000	300	1.0	3.0	14.5	8.5
	E	500	500	200	1.0	3.0	23.5	19.0

NOTE

- 1 With a 12V motor, the current is approximately twice the current measured in 24V; speed will be similar for both voltages.
- 2 This self-locking force level is reached only when a short circuit is applied on the terminals of the motor. All the TiMOTION control boxes have this feature built-in.
- 3 Please refer to the approved drawing for the final authentic value.

Standard Dimension (mm)

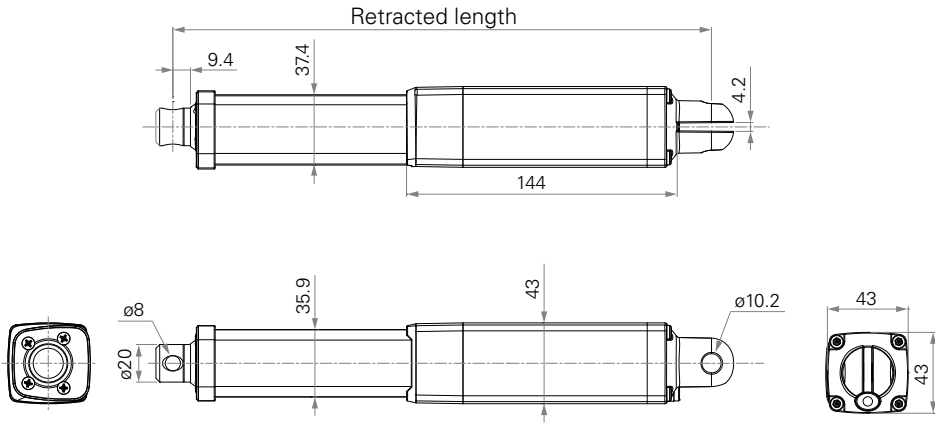

General Features

Maximum load	2,000N in push and pull
Maximum speed at full load	19mm/s (with 500N in a push or pull condition)
Stroke	20~1000mm
Minimum installation dimension	Stroke+217mm
IP rating	Up to IP69K
Color	Black or grey
Certificate	UL73
Operational temperature range	-5°C~+65°C
Operational temperature range at full performance	+5°C~+45°C
Storage temperature range	-40°C~+70°C
An inline actuator designed for small spaces	

Performance Data

Motor Speed 5600RPM, Duty Cycle 10%

Speed vs. Thrust

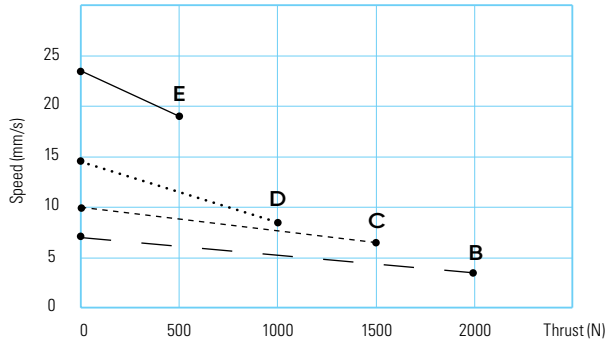

Current vs. Thrust

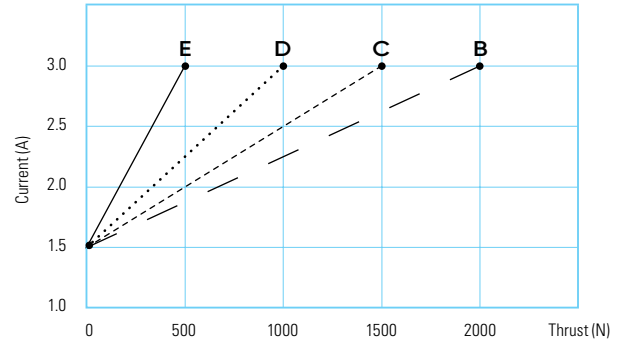

NOTE

1 The performance data in the curve charts shows theoretical value.

JP3 Ordering Key

JP3

Version: 20171204-C

Voltage	1 = 12V DC 2 = 24V DC	5 = 24V DC, PTC 6 = 12VDC, PTC	
Load and Speed	See page 4		
Stroke (mm)			
Restracted Length (mm)	See page 8		
Rear Attachment (mm)	1 = Aluminum casting, U clevis, slot 4.2, depth 18, hole 10.2 See page 9		
Front Attachment (mm)	1 = Aluminum casting, no slot, hole 6.4 2 = Aluminum casting, no slot, hole 8 3 = Aluminum casting, U clevis, slot 6, depth 13, hole 10 4 = Aluminum casting, U clevis, slot 6, depth 13, hole 6.4 5 = Aluminum casting, U clevis, slot 6, depth 13, hole 8 6 = Aluminum casting, hole 10 See page 9		
Direction of Rear Attachment (Counterclockwise)	1 = 0° See page 9		
Color	1 = Black	2 = Grey (Pantone428C)	
IP Rating	1 = Without 2 = IP54 3 = IP66	5 = IP66W 6 = IP66D 7 = IP68	8 = IP69K
Special Functions for Spindle Sub-Assembly	0 = Without (standard)		
Functions for Limit Switches	1 = Two switches at full retracted / extended positions to cut current 2 = Two switches at full retracted / extended positions to cut current + 3rd LS to send signal 3 = Two switches at full retracted / extended positions to send signal 4 = Two switches at full retracted / extended positions to send signal + 3rd LS to send signal		
Output Signals	0 = Without	1 = Hall sensor*1	2 = Hall sensors*2
Connector	1 = DIN 6P, 90° plug See page 9	2 = Tinned leads	
Cable Length (mm)	0 = Straight, 100	1 = Straight, 500	3 = Straight, 1000

JP3

Ordering Key Appendix

Retracted Length (mm)

1. Calculate $A+B+C = Y$
2. Retracted length needs to \geq Stroke+Y

A. Attachment	Front Attachment Code		Rear Attachment Code	
			1	
	1, 2		+217	
	3, 4, 5		+230	
B. Stroke (mm)	20~150	-	551~600	+40
	151~200	-	601~650	+45
	201~250	+ 5	651~700	+50
	251~300	+10	701~750	+55
	301~350	+15	751~800	+60
	351~400	+20	801~850	+65
	401~450	+25	851~900	+70
	451~500	+30	901~900	+75
	501~550	+40	951~1000	+80
C. Output Signals	Code			
	0		-	
	1, 2		+13	

Functions for Limit Switches

Wire Definitions

	Pin	CODE			
		1	2	3	4
● Green	1	Extend (VDC+)	Extend (VDC+)	Extend (VDC+)	Extend (VDC+)
● Red	2	N/A	N/A	Common	Common
○ White	3	N/A	Middle switch pinB	Upper limit switch	Upper limit switch
● Black	4	N/A	Middle switch pinA	N/A	Medium limit switch
● Yellow	5	Retract (VDC+)	Retract (VDC+)	Retract (VDC+)	Retract (VDC+)
● Blue	6	N/A	N/A	Lower limit switch	Lower limit switch

NOTE

1 See ordering key - functions for limit switches.

Rear Attachment (mm)

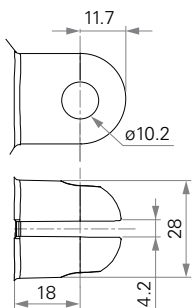

1 = Aluminum casting, U clevis, slot 4.2, depth 18, hole 10.2

Front Attachment (mm)

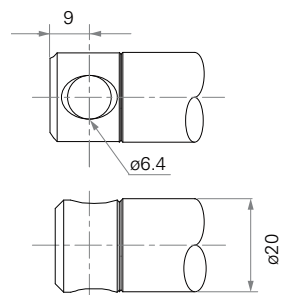

1 = Aluminum casting, no slot, hole 6.4

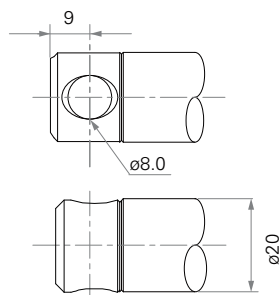

2 = Aluminum casting, no slot, hole 8

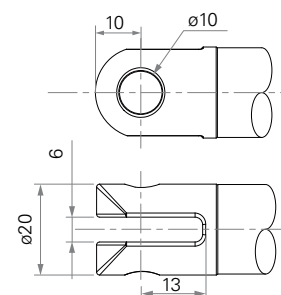

3 = Aluminum casting, U clevis, slot 6, depth 13, hole 10

Direction of Rear Attachment Counterclockwise

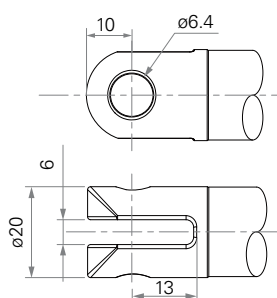

4 = Aluminum casting, U clevis, slot 6, depth 13, hole 6.4

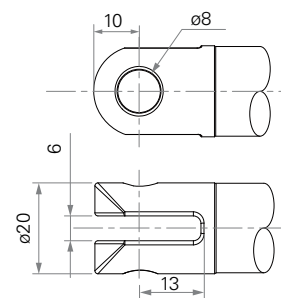

5 = Aluminum casting, U clevis, slot 6, depth 13, hole 8

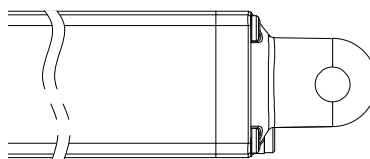

1 = 0°

Connector

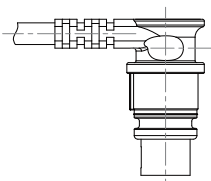

1 = DIN 6P, 90° plug

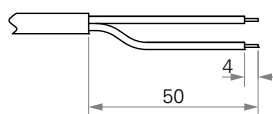

2 = Tinned leads

JP4

series

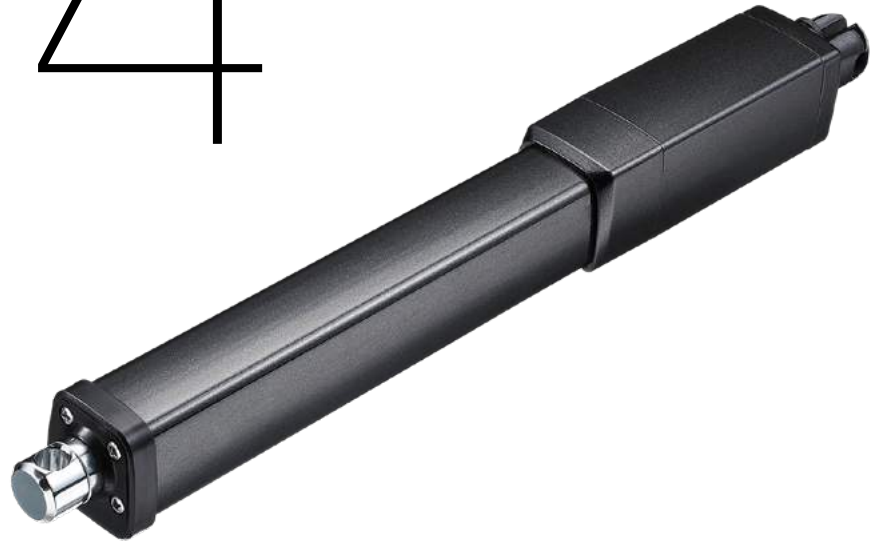

TiMOTION's JP4 series inline linear actuator is most similar to the JP3, but was designed for industrial applications that require higher load and speed. Its IP69K protection ensures it will withstand high temperature, high pressure water jets, and the ingress of dust and other solid contaminants. For synchronization and position feedback, the JP4 can be equipped with Hall sensors.

Load and Speed

	CODE	Load (N)		Self Locking Force (N)	Typical Current (A)		Typical Speed (mm/s)	
		Push	Pull		No Load 24V DC	With Load 24V DC	No Load 24V DC	With Load 24V DC
Motor Speed (3800RPM)	B	4500	3000	3000	1.1	4.0	4.4	2.5
	C	3500	3000	2000	1.1	4.0	6.5	4.0
	D	2500	2500	1000	1.1	4.0	9.2	5.6
	E	1500	1500	500	1.1	3.0	12.0	9.5
	F	1000	1000	250	1.1	3.0	18.5	14.0
	G	500	500	100	1.1	3.0	27.5	24.0

NOTE

- 1 With a 12V motor, the current is approximately twice the current measured in 24V; speed will be similar for both voltages.
- 2 This self-locking force level is reached only when a short circuit is applied on the terminals of the motor. All the TiMOTION control boxes have this feature built-in.
- 3 Please refer to the approved drawing for the final authentic value.

Standard Dimension (mm)

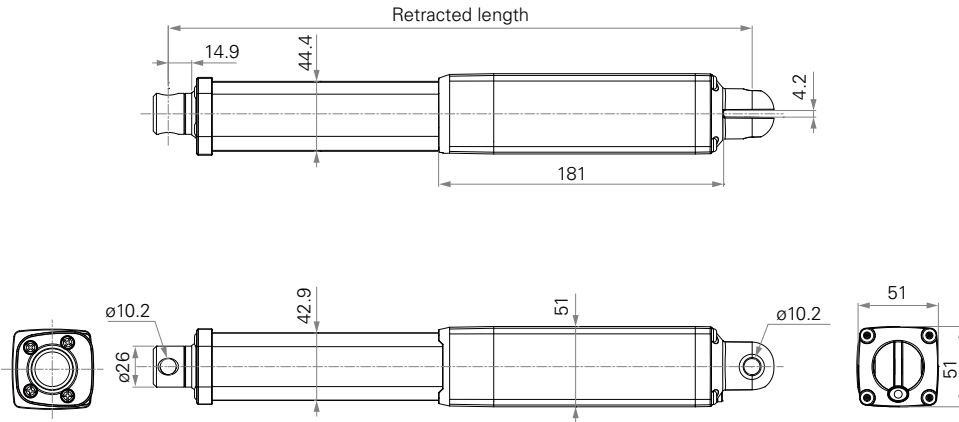

General Features

Maximum load	4,500N in push
Maximum load	3,000N in pull
Maximum speed at full load	24mm/s (with 500N in a push or pull condition)
Minimum installation dimension	Stroke+289mm
Stroke	20~1000mm
IP rating	Up to IP69K
Color	Black or grey
Operational temperature range	-5°C~+65°C
Operational temperature range at full performance	+5°C~+45°C
Storage temperature range	-40°C~+70°C
Certificate	UL73
An inline actuator designed for small spaces	

Performance Data

Motor Speed 3800RPM, Duty Cycle 10%

Speed vs. Thrust

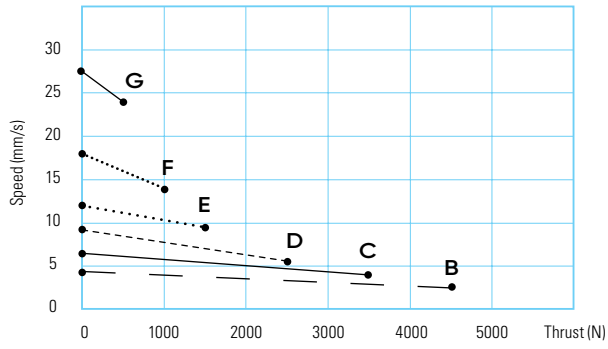

Current vs. Thrust

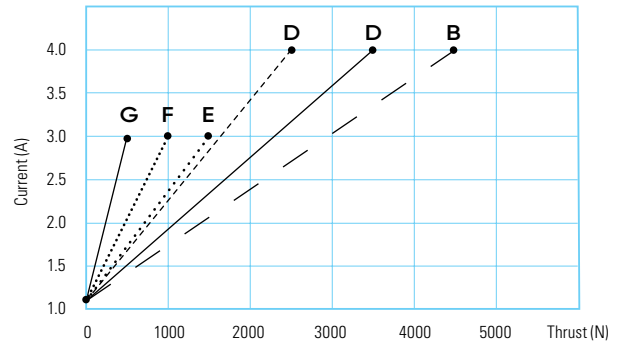

NOTE

1 The performance data in the curve charts shows theoretical value.

JP4 Ordering Key

JP4

Version: 20171204-C

Voltage	1 = 12V DC 2 = 24V DC	5 = 24V DC, PTC 6 = 12V DC, PTC	
Load and Speed	See page 10		
Stroke (mm)			
Restracted Lengh (mm)	See page 14		
Rear Attachment (mm)	1 = Aluminum casting, U clevis, slot 4.2, depth 18, hole 10.2 See page 15		
Front Attachment (mm)	1 = Aluminum CNC, no slot, hole 13 See page 15		
Direction of Rear Attachment (Counterclockwise)	1 = 0° See page 15		
Color	1 = Black	2 = Grey (Pantone428C)	
IP Rating	1 = Without 2 = IP54 3 = IP66	5 = IP66W 6 = IP66D 7 = IP68	8 = IP69K
Special Functions for Spindle Sub-Assembly	0 = Without (standard)		
Functions for Limit Switches	1 = Two switches at full retracted / extended positions to cut current 2 = Two switches at full retracted / extended positions to cut current + 3rd LS to send signal 3 = Two switches at full retracted / extended positions to send signal 4 = Two switches at full retracted / extended positions to send signal + 3rd LS to send signal		
Output Signals	0 = Without	1 = Hall sensor*1	2 = Hall sensor*2
Connector	1 = DIN 6P, 90° plug See page 15	2 = Tinned leads	
Cable Length (mm)	0 = Straight, 100	1 = Straight, 500	3 = Straight, 1000

JP4

Ordering Key Appendix

Retracted Length (mm)

1. Calculate $A+B=Y$
2. Retracted length needs to \geq Stroke+Y

A. Attachment	Front Attachment Code		Rear Attachment Code	
			1	
	1		+289	
B. Stroke (mm)	20~150	-	551~600	+80
	151~200	-	601~650	+90
	201~250	+10	651~700	+100
	251~300	+20	701~750	+110
	301~350	+30	751~800	+120
	351~400	+40	801~850	+130
	401~450	+50	851~900	+140
	451~500	+60	901~950	+150
	501~550	+70	951~1000	+160

Functions for Limit Switches

Wire Definitions

	Pin	CODE			
		1	2	3	4
● Green	1	Extend (VDC+)	Extend (VDC+)	Extend (VDC+)	Extend (VDC+)
● Red	2	N/A	N/A	Common	Common
○ White	3	N/A	Middle switch pinB	Upper limit switch	Upper limit switch
● Black	4	N/A	Middle switch pinA	N/A	Medium limit switch
● Yellow	5	Retract (VDC+)	Retract (VDC+)	Retract (VDC+)	Retract (VDC+)
● Blue	6	N/A	N/A	Lower limit switch	Lower limit switch

NOTE

¹ See ordering key - functions for limit switches.

Rear Attachment
(mm)

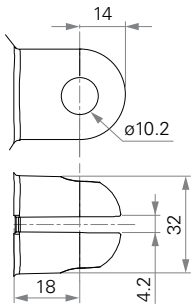

1 = Aluminum casting, U clevis, slot 4.2, depth 18, hole 10.2

Front Attachment
(mm)

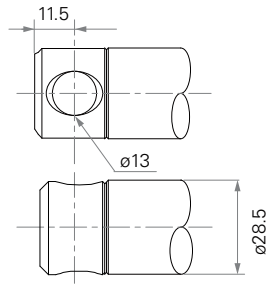

1 = #45 Steel CNC, no slot, hole 13

Direction of Rear Attachment
Counterclockwise

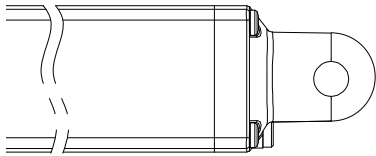

1 = 0°

Connector

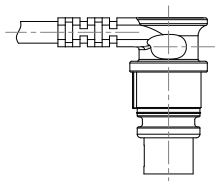

1 = DIN 6P, 90° plug

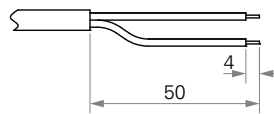

2 = Tinned leads

MA1

series



TiMOTION's MA1 series linear actuator is the proven choice for applications requiring a durable, long life solution. Specifically designed for harsh working environments, the MA1 linear actuator is ideal for use in heavy-duty machinery, industrial equipment and off road vehicles. This linear actuator has been certified for applications requiring IP66 dynamic compliance. Available options for the MA1 linear actuator include AC or DC power, ball or acme spindles, mechanical or electrical braking and a load limiting clutch or limit switches.

Load and Speed

	CODE	Load (N)		Typical Current (A)				Typical Speed (mm/s)				Overload Clutch Range (N)
		Push	Pull	No Load		With Load		No Load		With Load		
				12V DC	24V DC	12V DC	24V DC	12V DC	24V DC	12V DC	24V DC	
ACME Screw, DC Motor	B	1500	1500	10.0	5.0	15.4	7.7	29.5	29.5	27.0	27.0	1800~3300
	C	2500	2500	5.0	2.5	14.0	7.0	15.8	15.8	14.3	14.3	3000~5500
Ball Screw, DC Motor	A	2500	2500	7.0	3.5	30.0	12.5	58.5	58.5	36.5	48.0	3000~5500
	B	3500	3500	5.0	2.5	18.0	9.0	29.8	29.8	25.5	25.5	4200~7700
	C	4500	4500	4.0	2.0	13.0	6.5	16.0	16.0	14.0	14.0	5400~9900

	CODE	Load (N)		Typical Current (A)				Typical Speed (mm/s)				Overload Clutch Range (N)
		Push	Pull	No Load		With Load		No Load		With Load		
				110V AC	220V AC	110VA C	220V AC	110V AC	220V AC	110V AC	220V AC	
ACME Screw, AC Motor	B	1500	1500	1.9	0.9	2.0	1.0	26.1	22.5	23.0	21.0	1800~3300
	C	2500	2500	1.9	0.9	2.0	1.0	14.1	12.0	12.8	11.2	3000~5500
Ball Screw, AC Motor	A	2500	2500	2.0	0.9	2.5	1.3	53.0	46.0	38.5	40.0	3000~5500
	B	3500	3500	1.9	0.9	2.1	1.1	27.0	23.5	22.5	21.5	4200~7700
	C	4500	4500	1.9	0.9	2.0	1.0	14.5	12.0	13.0	11.5	5400~9900

NOTE

- 1 This self-locking force level is reached only when a short circuit is applied on the terminals of the motor. All the TiMOTION control boxes have this feature built-in.
- 2 Current and speed: Tested average value when stretching in push direction.
- 3 Standard stroke (ACME): 20~1000mm. Standard stroke (BALL): 50~1000m.
- 4 Please refer to the approved drawing for the final authentic value.

Standard Dimension (mm)

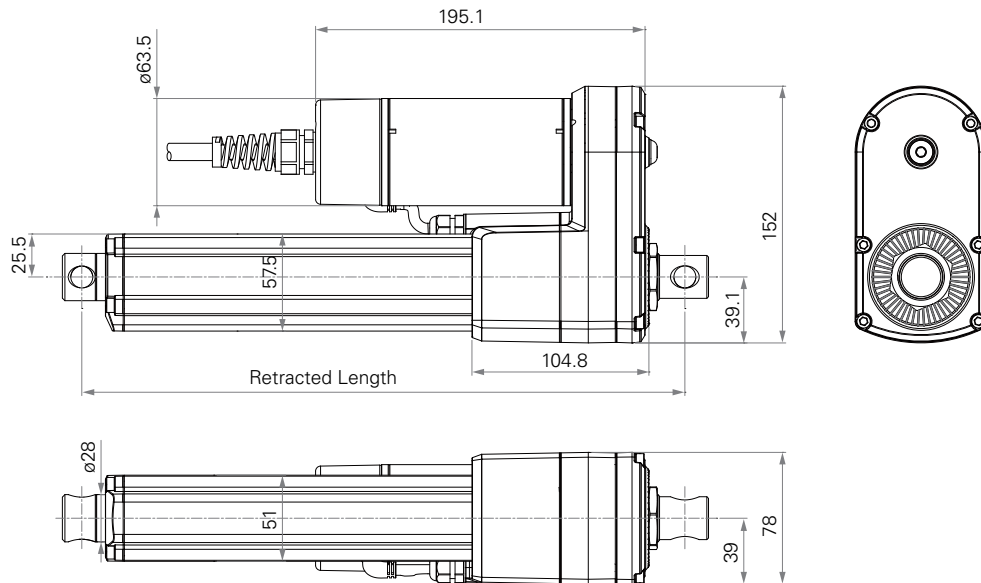

General Features

Spindle	ACME or Ball screw
Maximum load	4,500N in push and pull
Maximum speed at full load	48mm/s (Ball screw, 24V DC motor, with 2500N)
Minimum installation dimension	Stroke+160mm (without POT)
IP rating	IP66D
Operational temperature range	-30°C~+65°C
Operational temperature range at full performance	+5°C~+45°C
Options	Overload clutch, Hall sensor(s), POT, manual drive function
Mechanical or electromagnetic brake	
Duty cycle (25%), corrosion proof	

Performance Data

ACME Screw 12V DC Motor, Duty Cycle 25%

Speed vs. Thrust

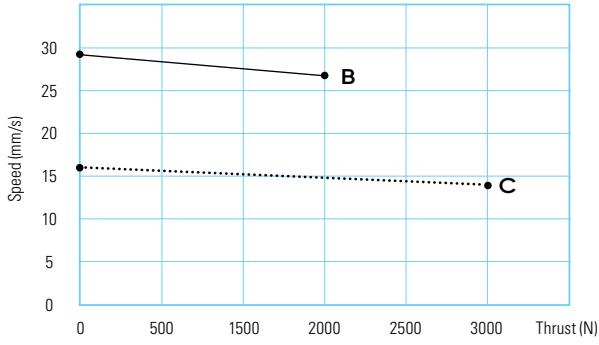

Current vs. Thrust

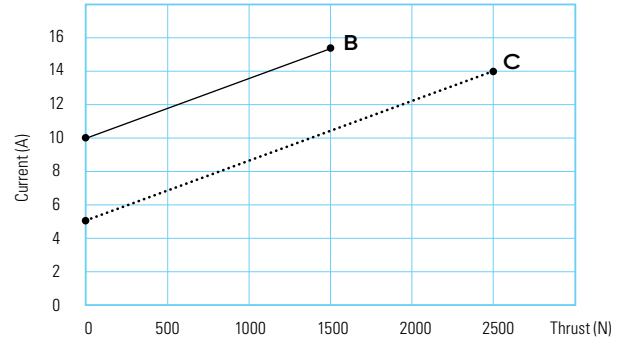

ACME Screw 24V DC Motor, Duty Cycle 25%

Speed vs. Thrust

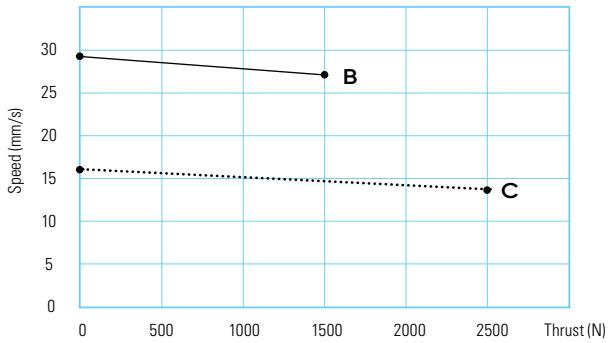

Current vs. Thrust

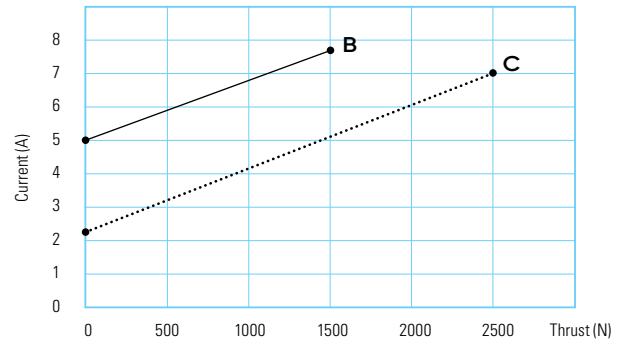

NOTE

1 The performance data in the curve charts shows theoretical value.

Performance Data

Ball Screw 12V DC Motor, Duty Cycle 25%

Speed vs. Thrust

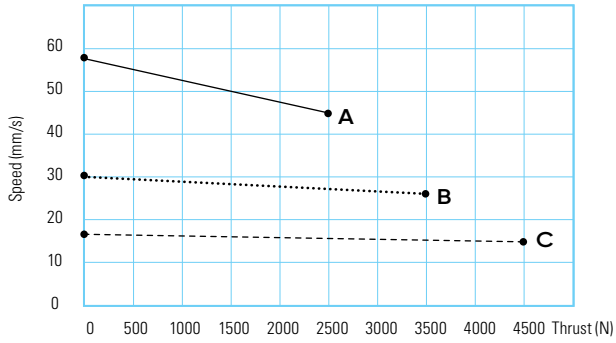

Current vs. Thrust

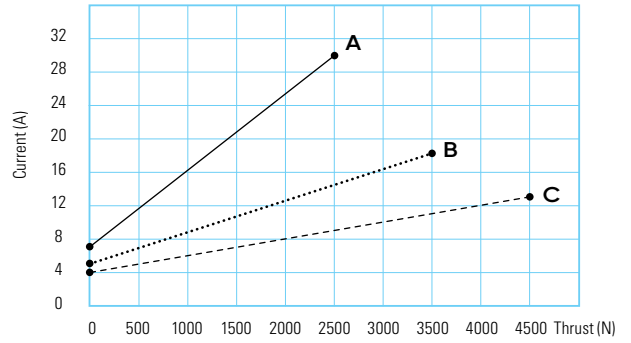

Ball Screw 24V DC Motor, Duty Cycle 25%

Speed vs. Thrust

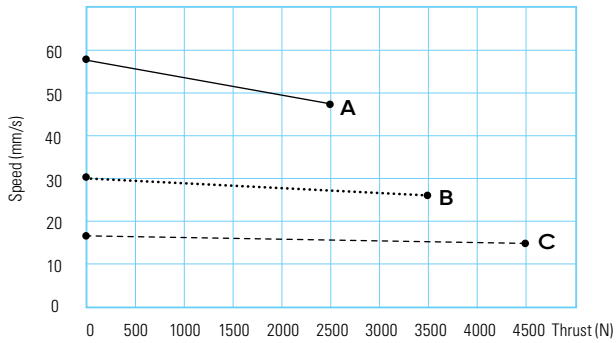

Current vs. Thrust

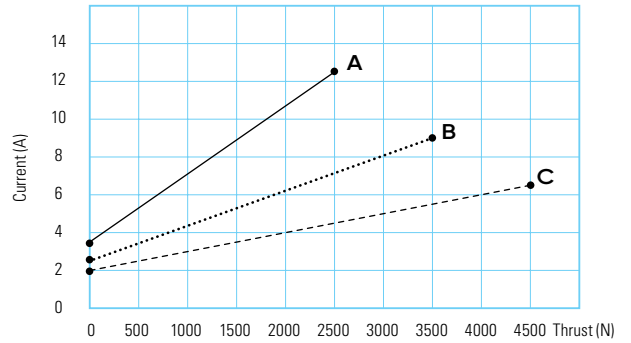

Performance Data

ACME Screw 110V AC Motor, Duty Cycle 25%

Speed vs. Thrust

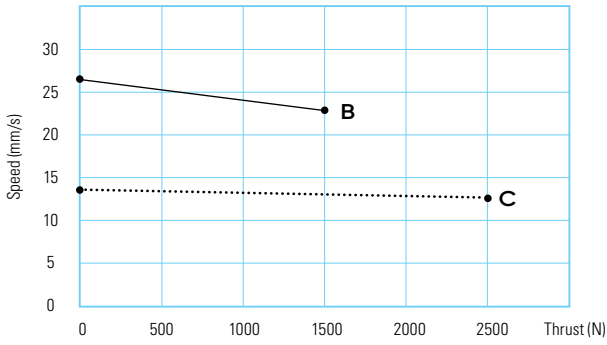

Current vs. Thrust

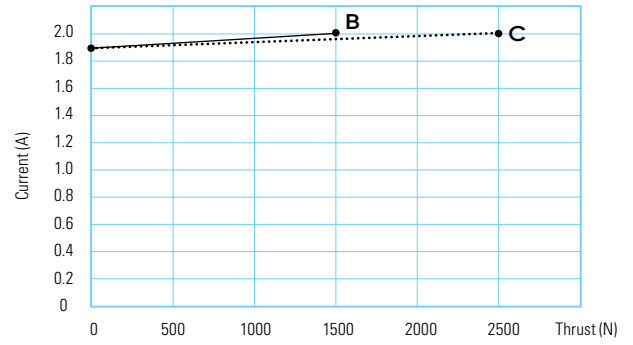

ACME Screw 220V AC Motor, Duty Cycle 25%

Speed vs. Thrust

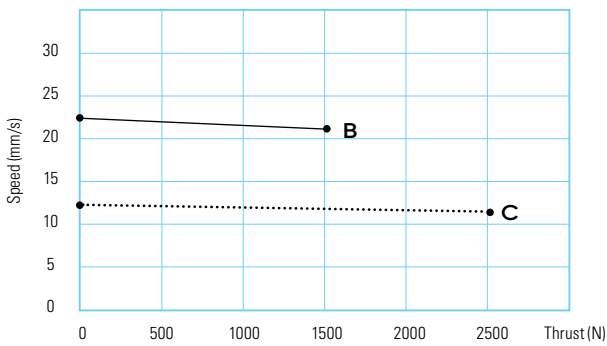

Current vs. Thrust

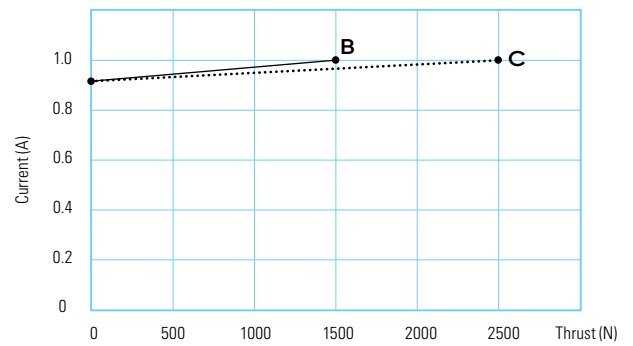

NOTE

1 The performance data in the curve charts shows theoretical value.

Performance Data

Ball Screw 110V AC Motor, Duty Cycle 25%

Speed vs. Thrust

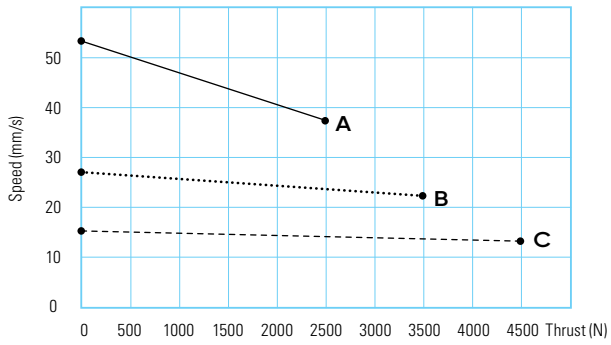

Current vs. Thrust

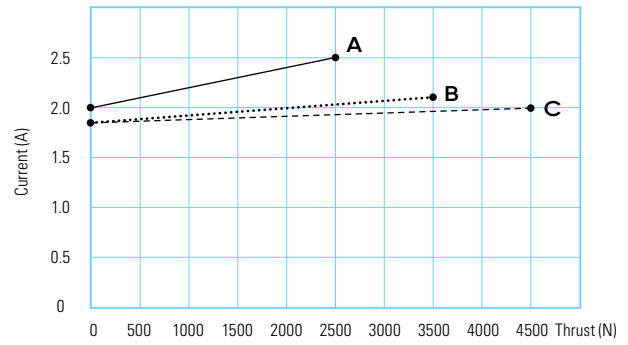

Ball Screw 220V AC Motor, Duty Cycle 25%

Speed vs. Thrust

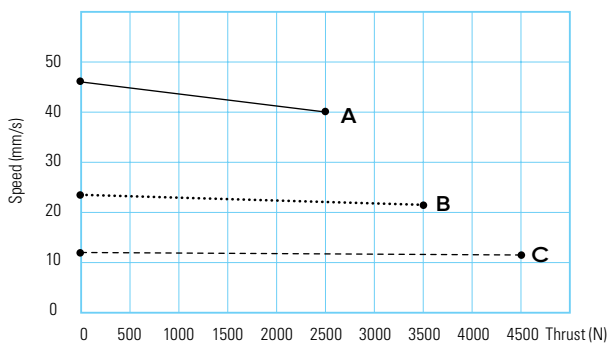

Current vs. Thrust

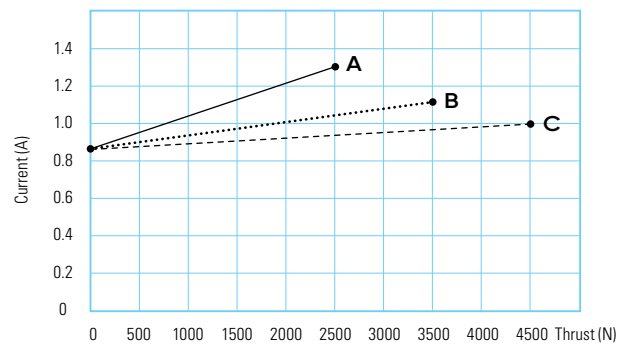

MA1 Ordering Key

MA1

Version: 20170710-B

Spindle Type	A = ACME screw	B = Ball screw	
Voltage	1 = 12V DC 2 = 24V DC	3 = 36V DC 4 = 110V AC 60Hz	5 = 220V AC 50Hz
Load and Speed	See page 16		
Stroke (mm)			
Restracted Length (mm)	See page 23		
Rear Attachment (mm)	1 = #45 Steel CNC, without slot, hole 13 See page 25		
Front Attachment (mm)	1 = #45 Steel CNC, without slot, hole 13 See page 25		
Direction of Rear Attachment (Counterclockwise)	1 = 90° (Standard)	2 = 0°	See page 25
Functions for Limit Switches	0 = Without (Needs to choose overload clutch) 1 = Two switches at full retracted / extended positions to cut current 2 = Two switches at full retracted / extended positions to send signal		
Overload Clutch	0 = Without	1 = With (Standard)	
Mechanical Brake	0 = Without	1 = With (Ball screw's standard option)	
Electromagnetic Brake	0 = Without (Standard)	1 = With	
IP Rating	6 = IP66D		
Manual Drive	0 = Without	1 = With	
Output Signals	0 = Without 1 = POT	4 = Hall sensor*1 5 = Hall sensors*2	
Connector	1 = Tinned leads		
Cable Length (mm)	1 = Straight, 500		

MA1

Ordering Key Appendix

Retracted Length (mm)

1. Calculate $A+B+C = Y$
2. Retracted length needs to \geq Stroke+Y

A. Type	ACME Screw DC Motor		Ball Screw DC Motor		ACME Screw AC Motor		Ball Screw AC Motor		
	+160		+201		+160		+201		
B. Mechanical Brake	Code	Type							
		ACME Screw DC Motor		Ball Screw DC Motor		ACME Screw AC Motor		Ball Screw AC Motor	
	0	-	-	-	-	-	-	-	
1	+35	-	-	+35	-	-	-		
C. Output Signal	Code	Type							
		ACME Screw DC Motor		Ball Screw DC Motor		ACME Screw AC Motor		Ball Screw AC Motor	
	0	-	-	-	-	-	-	-	
	1	+36	+40	+36	+40	+36	+40	+40	
	4	-	-	+36	+40	+36	+40	+40	
5	-	-	+36	+40	+36	+40	+40		

*For long stroke, there is no need for additional retracted length.

Functions for Limit Switches

Wire Definitions

				Output signal code			
		AWG		0 Without	1 POT	4 1 Hall	5 2 Hall
DC motor	Motor side	● Black	26	-	-	GND	GND
		● Blue	26	-	-	-	S2
		○ White	26	-	-	S1	S1
		● Red	26	-	-	+5V	+5V
		● Green	16	Extend+	Extend+	Extend+	Extend+
		● Yellow	16	Extend+	Extend+	Extend+	Extend+
	Gear box side	● Red	26	-	Pin 1	-	-
		○ White	26	-	Pin 2	-	-
		● Black	26	-	Pin 3	-	-
AC motor	Motor side	● Black	18	Extend+	Extend+	Extend+	Extend+
		● Grey	18	Extend+	Extend+	Extend+	Extend+
		● Brown	18	PCBA+	PCBA+	PCBA+	PCBA+
		● Blue	18	Neutral	Neutral	Neutral	Neutral
		● Green/Yellow	18	GND	GND	GND	GND
		Gear box side	● Red	20	-	Pin1	+5V
	○ White		20	-	Pin2	S1	S1
	● Blue		20	-	-	-	S2
			● Black	20	-	Pin3	GND

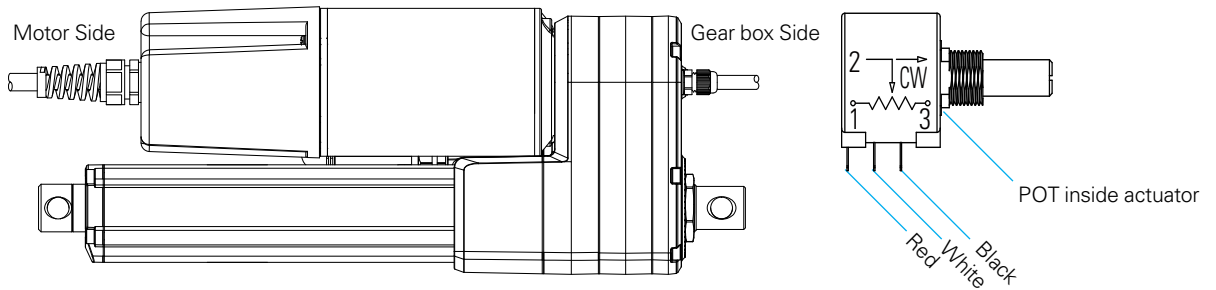

Rear Attachment (mm)

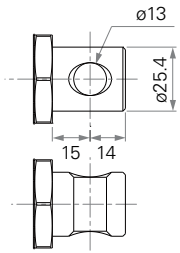

1 = #45 Steel CNC, without slot, hole 13

Front Attachment (mm)

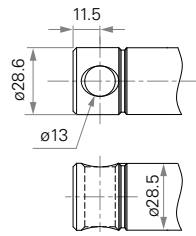

1 = #45 Steel CNC, without slot, hole 13

Direction of Rear Attachment Counterclockwise

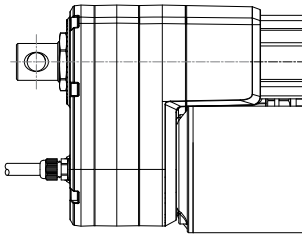

1 = 90°

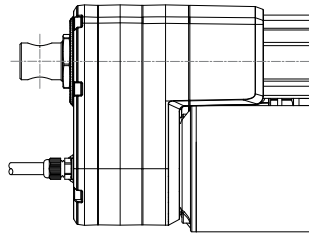

2 = 0°

MA2

series



TiMOTION's MA2 series linear actuator was specifically designed for applications which face harsh working environments and require ruggedness and durability. Its IP69K protection ensures it will withstand high temperature, high pressure water jets, and the ingress of dust and other solid contaminants. The MA2 also has optional Reed switches along the outer tube which allow users to adjust the stroke length. For improved control and accuracy of motion, the MA2 can be customized with many different feedback options depending on your application requirements. Example applications suitable for the MA2: Agricultural equipment such as spreaders, harvesters, grain handlers, combines and tractors.

Load and Speed

	CODE	Load (N)		Self Locking Force (N)	Typical Current (A)		Typical Speed (mm/s)	
		Push	Pull		No Load 24V DC	With Load 24V DC	No Load 24V DC	With Load 24V DC
Motor Speed (5200RPM)	F	1000	1000	1300	2.7	8.4	52.5	43.0
	G	2000	2000	2600	2.4	7.5	25.5	22.3
	H	4000	4000	5200	2.3	8.0	13.2	11.1
	J	6000	6000	7800	2.0	6.8	6.6	6.1

NOTE

- 1 With a 12V motor, the current is approximately twice the current measured in 24V. With a 36V motor, the current is approximately two-thirds the current measured in 24V; speed will be similar for both voltages.
- 2 This self-locking force level is reached only when a short circuit is applied on the terminals of the motor. All the TiMotion control boxes have this feature built-in.
- 3 Please refer to the approved drawing for the final authentic value.

Standard Dimension (mm)

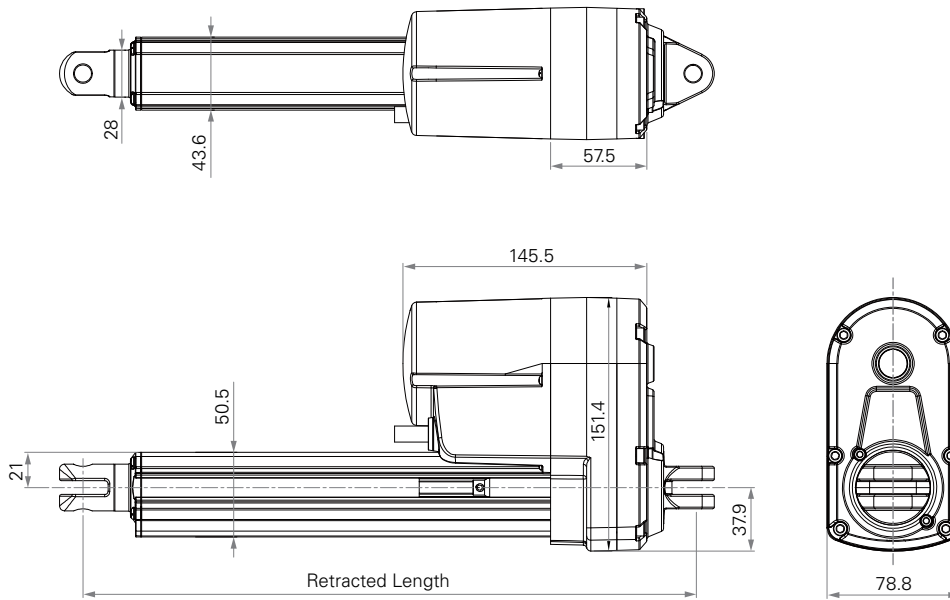

General Features

Maximum load	6,000N in push and pull
Maximum speed at full load	43mm/s (with 1000N in a push or pull condition)
Stroke	25~1000mm
Minimum installation dimension	Stroke+131mm
IP rating	Up to IP69K
Operational temperature range	-30°C~+65°C
Operational temperature range at full performance	+5°C~+45°C
Options	Hall sensor(s), POT

Performance Data

Motor Speed 5200RPM, Duty Cycle 25%

Speed vs. Thrust

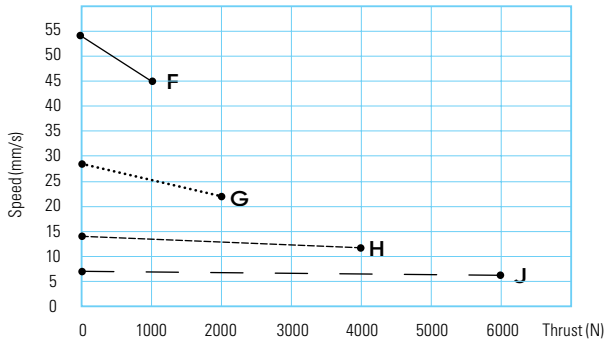

Current vs. Thrust

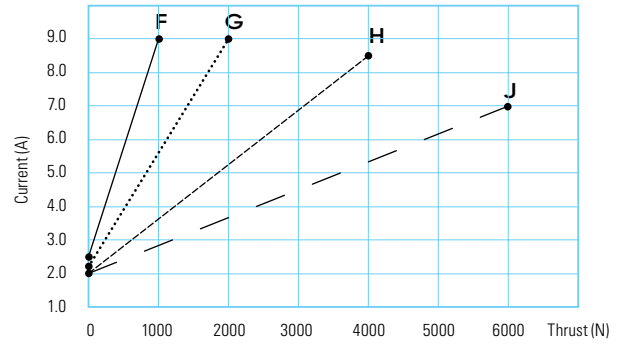

NOTE

1 The performance data in the curve charts shows theoretical value.

MA2 Ordering Key

MA2

Version: 20171221-C

Voltage	1 = 12V DC 2 = 24V DC	3 = 36V DC 5 = 24V DC, thermal control	6 = 12V DC, thermal control 7 = 36V DC, thermal control
Load and Speed	See page 26		
Stroke (mm)			
Restracted Lengh (mm)	See page 30		
Rear Attachment (mm) See page 32	1 = Aluminum casting, clevis U, slot 8.2, depth 12.5, hole 10.2 2 = Aluminum casting, clevis U, slot 8.2, depth 15, hole 10.2 3 = Aluminum casting, clevis U, slot 8.2, depth 15, hole 12.8 4 = Aluminum casting, clevis U, slot 8.2, depth 15, hole 12.2		
Front Attachment (mm) See page 32	1 = Iron inner tube with punched hole, without slot, hole 10.2 2 = Iron inner tube with punched hole, without slot, hole 12.2 3 = Iron inner tube with punched hole, without slot, hole 12.8 4 = Aluminum casting, clevis U, slot 8.2, depth 15, hole 10.2 5 = Aluminum casting, clevis U, slot 8.2, depth 15.0, hole 12.2 6 = Aluminum casting, clevis U, slot 8.2, depth 15, hole 12.8 K = Rod end bearing, hole 12.8		
Direction of Rear Attachment (Counterclockwise)	1 = 90° See page 32	2 = 0°	
Functions for Limit Switches	1 = Two switches at full retracted / extended positions to cut current 2 = Two switches at full retracted / extended positions to cut current + third one in between to send signal 6 = Two switches at full retracted/extended positions to cut current + send signal		
Reed Sensor on the Outer Tube	0 = Without	1 = One Reed sensor	2 = Two Reed sensors
Output Signals	0 = Without 1 = POT	4 = Hall sensor*1 5 = Hall sensor*2	
Connector See page 33	2 = Tinned leads		
Cable Length (mm)	1 = Straight, 500 2 = Straight, 1000	3 = Straight, 1500 4 = Straight, 2000	
IP Rating	1 = Without 2 = IP54	3 = IP66 6 = IP66D	8 = IP69K
Manual Drive	0 = Without	1 = With	
T-Smart	0 = Without		

MA2

Ordering Key Appendix

Retracted Length (mm)

1. Calculate $A+B+C = Y$
2. Retracted length needs to \geq Stroke+Y

A. Attachment	Front Attachment Code		Rear Attachment Code	
			1	2, 3, 4
	1, 2, 3		+131	+134
	4, 5, 6		+161	+164
	K		+178	+181
B. Stroke (mm)	25~150	-	551~600	+80
	151~200	-	601~650	+90
	201~250	+10	651~700	+100
	251~300	+20	701~750	+110
	301~350	+30	751~800	+120
	351~400	+40	801~850	+130
	401~450	+50	851~900	+140
	451~500	+60	901~950	+150
	501~550	+70	951~1000	+160
C. Output Signals	Code			
	0, 4, 5, 6, 7		-	
	1		+20	

Functions for Limit Switches

Wire Definitions

		Pin	CODE		
			1	2	6
● Green	Green	1	Extend (VDC+)	Extend (VDC+)	Extend (VDC+)
● Red	Red	2	N/A	N/A	N/A
○ White	White	3	N/A	Middle switch pinB	Upper limit switch
● Black	Black	4	N/A	Middle switch pinA	Lower limit switch
● Yellow	Yellow	5	Retract (VDC+)	Retract (VDC+)	Retract (VDC+)
● Blue	Blue	6	N/A	N/A	N/A

NOTE

¹ See ordering key - functions for limit switches.

Rear Attachment (mm)

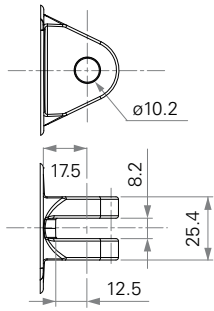

1 = Aluminum casting, clevis U, slot 8.2, depth 12.5, hole 10.2

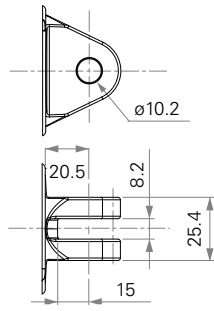

2 = Aluminum casting, clevis U, slot 8.2, depth 15, hole 10.2

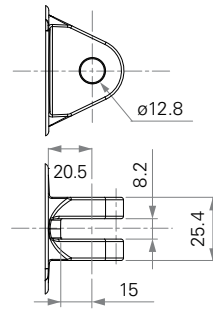

3 = Aluminum casting, clevis U, slot 8.2, depth 15, hole 12.8

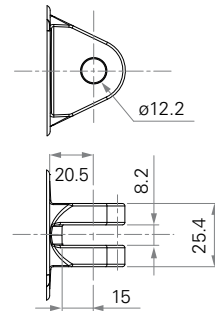

4 = Aluminum casting, clevis U, slot 8.2, depth 15, hole 12.2

Front Attachment (mm)

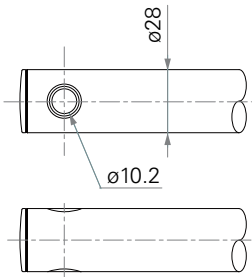

1 = Iron inner tube with punched hole, without slot, hole 10.2

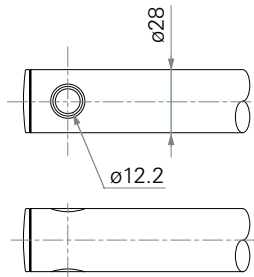

2 = Iron inner tube with punched hole, without slot, hole 12.2

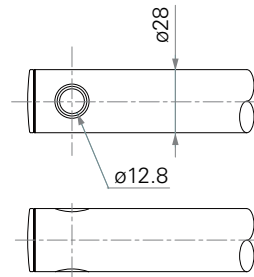

3 = Iron inner tube with punched hole, without slot, hole 12.8

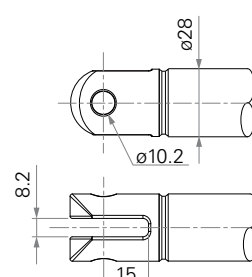

4 = Aluminum casting, clevis U, slot 8.2, depth 15, hole 10.2 (IP: IP66D, IP69K)

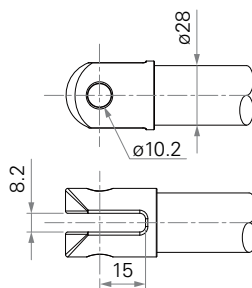

4 = Aluminum casting, clevis U, slot 8.2, depth 15, hole 10.2 (IP: Without, IP54)

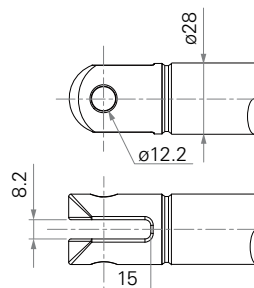

5 = Aluminum casting, clevis U, slot 8.2, depth 15, hole 12.2 (IP: IP66D, IP69K)

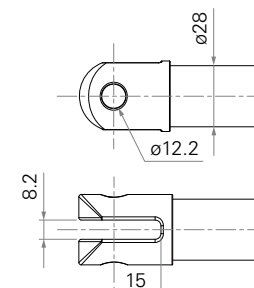

5 = Aluminum casting, clevis U, slot 8.2, depth 15, hole 12.2 (IP: Without, IP54)

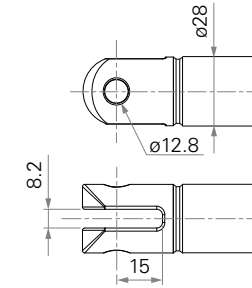

6 = Aluminum casting, clevis U, slot 8.2, depth 15, hole 12.8 (IP: IP66D, IP69K)

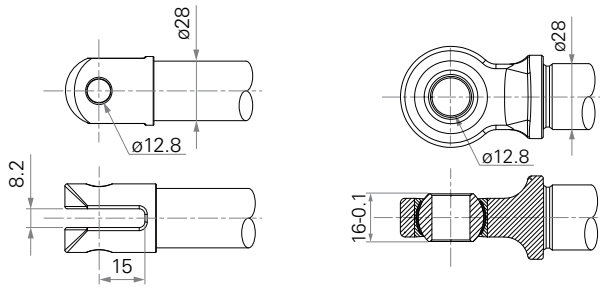

6 = Aluminum casting, clevis U, slot 8.2, depth 15, hole 12.8
 (IP: Without, IP54) K = Rod end bearing, hole 12.8

Direction of Rear Attachment Counterclockwise

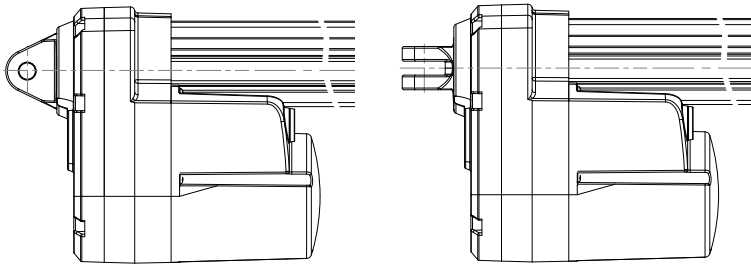

1 = 90°

2 = 0°

Connector

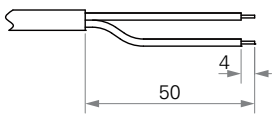

2 = Tinned leads

MA5 series

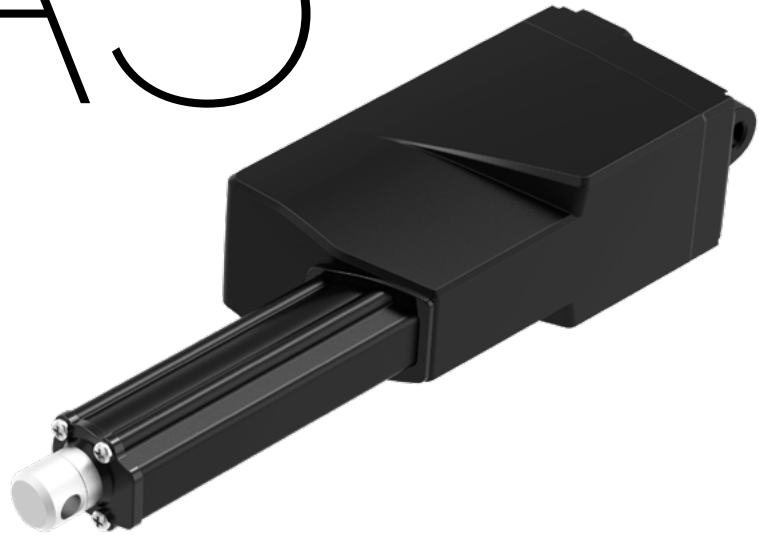

TiMOTION's MA5 series linear actuator was specifically designed for applications which face harsh working environments and require ruggedness and durability. Its IP69K protection ensures it will withstand high temperature, high pressure water jets, and the ingress of dust and other solid contaminants. The MA5 can be customized with many different feedback options depending on your application requirements and can be equipped with grease nipple to increase the protection and life. Example applications suitable for the MA5: Agricultural equipment such as spreaders, harvesters, grain handlers.

Load and Speed

	CODE	Load (N)		Self Locking Force (N)	Typical Current (A)		Typical Speed (mm/s)	
		Push	Pull		No Load 24V DC	With Load 24V DC	No Load 24V DC	With Load 24V DC
Motor Speed (5200RPM)	A	250	250	250	1.2	2.3	43.0	36.0
	B	500	500	500	1.1	2.3	25.8	23.0
	C	1000	1000	1000	1.1	2.3	14.0	11.8
	D	1500	1500	1500	1.0	2.2	9.0	8.0
	E	2000	2000	2000	1.0	2.2	7.1	6.2
	W	500	500	500	1.3	5.0	54.0	35.0
Motor Speed (6600RPM)	F	250	250	250	1.6	2.8	56.5	45.0
	G	500	500	500	1.5	2.8	32.5	28.5
	H	1000	1000	1000	1.5	2.8	16.5	14.3
	K	1500	1500	1500	1.3	2.8	11.1	10.0
	L	2000	2000	2000	1.3	2.8	8.8	7.7
Motor Speed (3800RPM)	S	3500	2000	3500	0.9	2.8	3.2	2.4
Motor Speed (2200RPM)	T	2000	2000	2000	0.3	1.2	3.2	2.4

NOTE

- 1 With a 12V motor, the current is approximately twice the current measured in 24V. With a 36V motor, the current is approximately two-thirds the current measured in 24V; speed will be similar for both voltages.
- 2 This self-locking force level is reached only when a short circuit is applied on the terminals of the motor. All the TiMotion control boxes have this feature built-in.
- 3 Please refer to the approved drawing for the final authentic value.

Standard Dimension (mm)

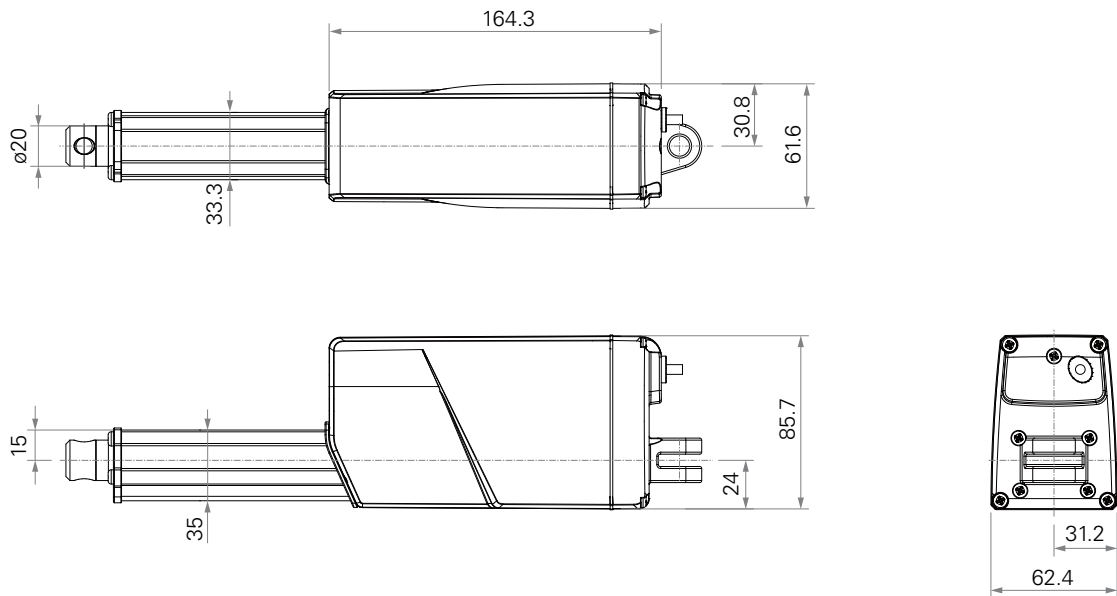

General Features

Maximum load	3,500N in push
Maximum load	2,000N in pull
Maximum speed at full load	45mm/s (with 250N in a push or pull condition)
Stroke	20~1000mm
Minimum installation dimension	≥ 238 or 250mm (upon the front attachment)
IP rating	Up to IP69K
Operational temperature range	-25°C ~ +65°C
Operational temperature range at full performance	+5°C~+45°C
Options	Hall sensor(s), POT

Performance Data

Motor Speed 5200RPM, Duty Cycle 25%

Speed vs. Thrust

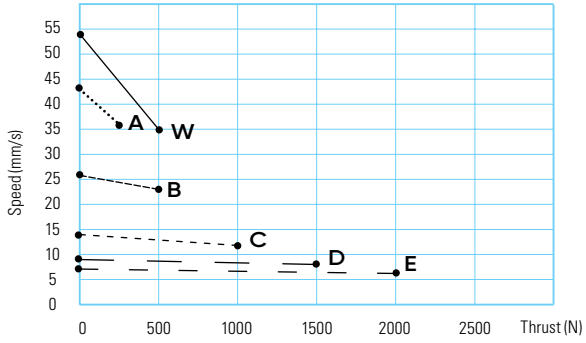

Current vs. Thrust

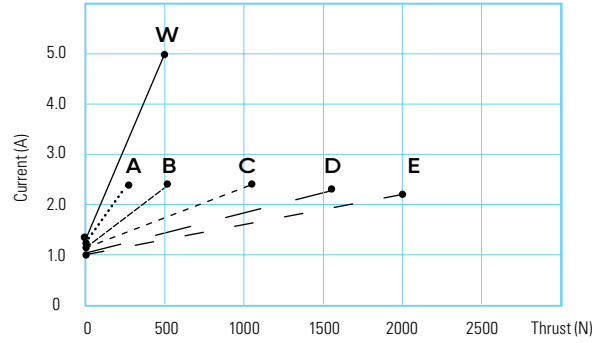

Motor Speed 6600RPM, Duty Cycle 25%

Speed vs. Thrust

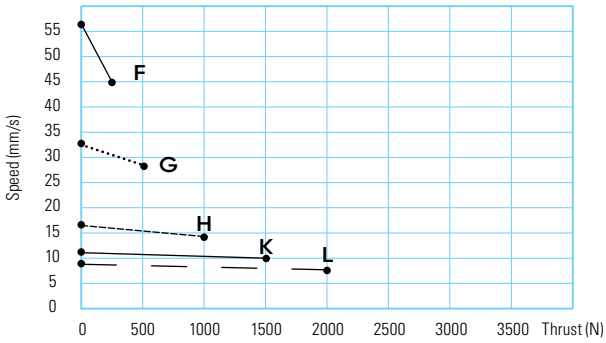

Current vs. Thrust

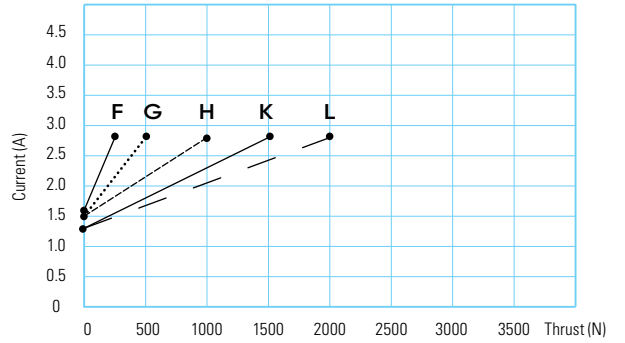

NOTE

1 The performance data in the curve charts shows theoretical value.

Performance Data

Motor Speed 3800RPM, Duty Cycle 25%

Speed vs. Thrust

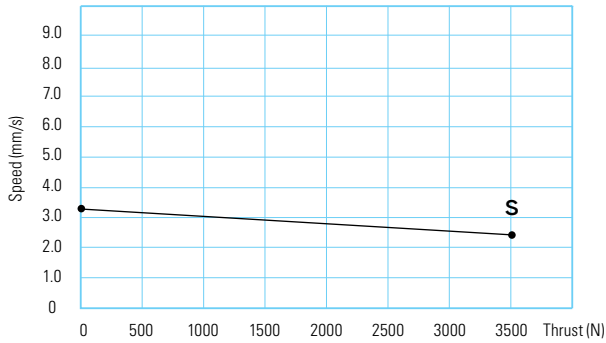

Current vs. Thrust

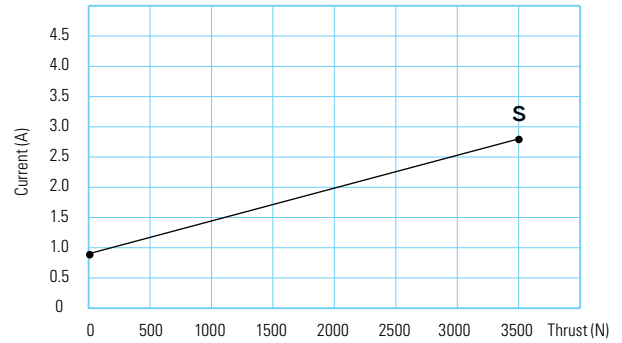

Motor Speed 2200RPM, Duty Cycle 25%

Speed vs. Thrust

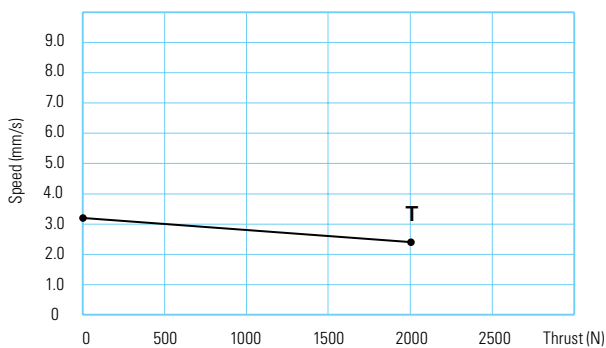

Current vs. Thrust

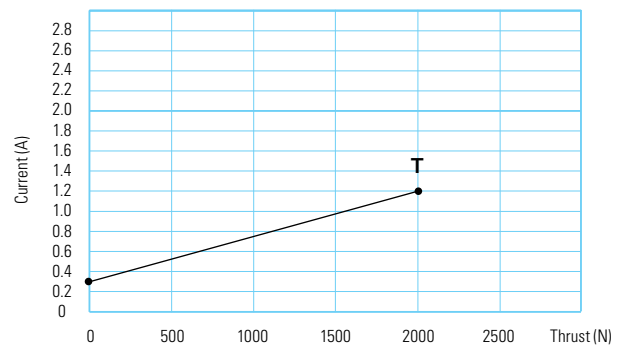

MA5 Ordering Key

MA5

Version: 20180621-B

Voltage	1 = 12V DC 2 = 24V DC	5 = 24VDC, PTC 6 = 12VDC, PTC
Load and Speed	See page 34	
Stroke (mm)		
Restracted Lengh (mm)	See page 39	
Rear Attachment (mm) See page 41	4 = Aluminum casting, U clevis, slot 6, width 10.5, hole 6.4, one piece casting with gear box 5 = Aluminum casting, U clevis, slot 6, width 10.5, hole 8, one piece casting with gear box 6 = Aluminum casting, U clevis, slot 6, width 10.5, hole 10, one piece casting with gear box	
Front Attachment (mm) See page 41	1 = Aluminum casting, hole 6.4 2 = Aluminum casting, hole 8 3 = Aluminum CNC, U clevis, slot 6, depth 16.0, hole 10 4 = Aluminum CNC, U clevis, slot 6, depth 16.0, hole 6.4 5 = Aluminum CNC, U clevis, slot 6, depth 16.0, hole 8	
Direction of Rear Attachment (Counterclockwise)	2 = 0° See page 41	
Functions for Limit Switches	1 = Two switches at full retracted / extended positions to cut current 2 = Two switches at full retracted / extended positions to cut current + third one in between to send signal 3 = Two switches at full retracted / extended positions to send signal 4 = Two switches at full retracted / extended positions to send signal + third one in between to send signal	
Output Signals	0 = Without 1 = POT	4 = Hall sensor*1 5 = Hall sensor*2
Connector See page 41	1 = DIN 6P, 90° plug	2 = Tinned leads
Cable Length (mm)	1 = Straight, 300	2 = Straight, 600 3 = Straight, 1000
IP Rating	6 = IP66D	9 = IP69K
Grease Nipple	0 = Without grease chamber 1 = With grease chamber and grease nipple*1	2 = With grease chamber and grease nipple*2

MA5

Ordering Key Appendix

Retracted Length (mm)

1. Calculate $A+B+C = Y$
2. Retracted length needs to \geq Stroke+Y
3. Front attachment #1, #2, min retracted length \geq 238
 Front attachment #3, #4, #5, min retracted length \geq 250

A. Front Attachment	1, 2	+152
	3, 4, 5	+164

B. Stroke (mm)	Load (N)	
	<3500	=3500
0~150	-	+5
151~200	+2	+7
201~250	+2	+7
251~300	+2	+7
301~350	+12	+17
351~400	+22	+27
401~450	+32	+37
451~500	+42	+47
501~550	+52	+57
551~600	+62	+67
601~650	+72	+77
651~700	+82	+87
701~750	+92	+97
751~800	+102	+107
801~850	+112	+117
851~900	+122	+127
901~950	+132	+137
951~1000	+142	+147

C. Output Signals	Code	
	0, 4, 5	-
	1	+30

**D.
Grease Chamber**







Code

0

1, 2

Functions for Limit Switches

Wire Definitions

		Pin	CODE			
			1	2	3	4
	Green	1	Extend (VDC+)	Extend (VDC+)	Extend (VDC+)	Extend (VDC+)
	Red	2	N/A	N/A	Common	Common
	White	3	N/A	Middle switch pinB	Upper limit switch	Upper limit switch
	Black	4	N/A	Middle switch pinA	N/A	Medium limit switch
	Yellow	5	Retract (VDC+)	Retract (VDC+)	Retract (VDC+)	Retract (VDC+)
	Blue	6	N/A	N/A	Lower limit switch	Lower limit switch

NOTE

¹ See ordering key - functions for limit switches.

Rear Attachment (mm)

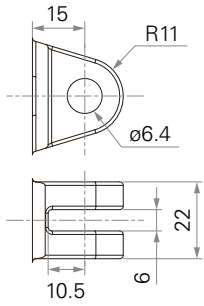

4 = Aluminum casting, U clevis, slot 6, width 10.5, hole 6.4, one piece casting with gear box

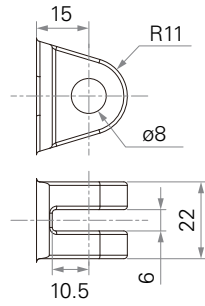

5 = Aluminum casting, U clevis, slot 6, width 10.5, hole 8, one piece casting with gear box

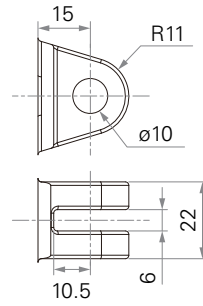

6 = Aluminum casting, U clevis, slot 6, width 10.5, hole 10, one piece casting with gear box

Front Attachment (mm)

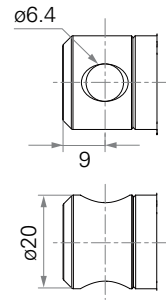

1 = Aluminum casting, hole 6.4

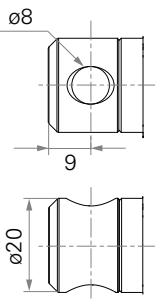

2 = Aluminum casting, hole 8

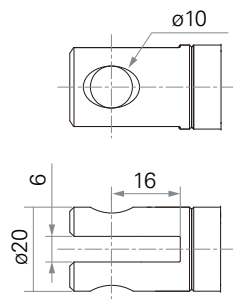

3 = Aluminum CNC, U clevis, slot 6, depth 16, hole 10

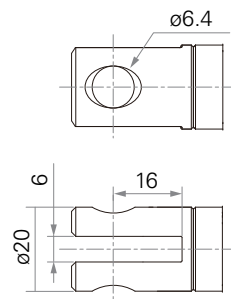

4 = Aluminum CNC, U clevis, slot 6, depth 16, hole 6.4

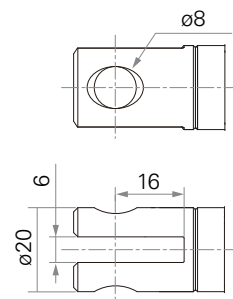

5 = Aluminum CNC, U clevis, slot 6, depth 16, hole 8

Direction of Rear Attachment Counterclockwise

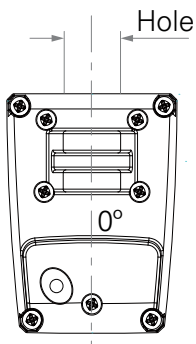

2 = 0°

Connector

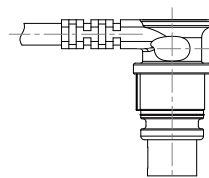

1 = DIN 6P, 90° plug

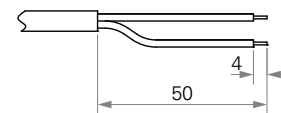

2 = Tinned leads

TA2 series



TiMOTION's TA2 series linear actuator is compact, robust and capable of performing well in certain outdoor environments. This linear actuator is perfect for use in small spaces where force or capability cannot be sacrificed. Options include feedback sensors, signal sending limit switches and 90 degree clevis mounting. Industry certifications for the TA2 linear actuator include UL73, EMC.

Load and Speed

	CODE	Load (N)		Self Locking Force (N)	Typical Current (A)		Typical Speed (mm/s)	
		Push	Pull		No Load 24V DC	With Load 24V DC	No Load 24V DC	With Load 24V DC
Motor Speed (4200RPM)	A	120	120	120	0.8	1.2	44.0	32.0
	B	240	240	240	0.7	1.2	22.0	16.5
	C	500	500	500	0.6	1.0	11.0	8.5
	D	750	750	750	0.6	1.0	7.5	6.2
	E	1000	1000	1000	0.6	1.0	5.6	4.6
Motor Speed (6000RPM)	F	120	120	120	1.0	1.8	67.5	51.0
	G	240	240	240	0.9	1.8	33.5	26.5
	H	500	500	500	0.8	1.5	17.0	14.0
	K	750	750	750	0.8	1.5	11.0	10.0
	L	1000	1000	1000	0.8	1.5	9.0	7.6

NOTE

- 1 Motor 12V current is around 2 times in 24V; Motor 36V current is around 2/3 in 24V; Motor 48V current is around 1/2 in 24V; speed is around the same.
- 2 Above self lock performance needs working with Timotion control system in push direction.
- 3 Please refer to the approved drawing for the final authentic value.

Standard Dimension (mm)

Without
Output Signal

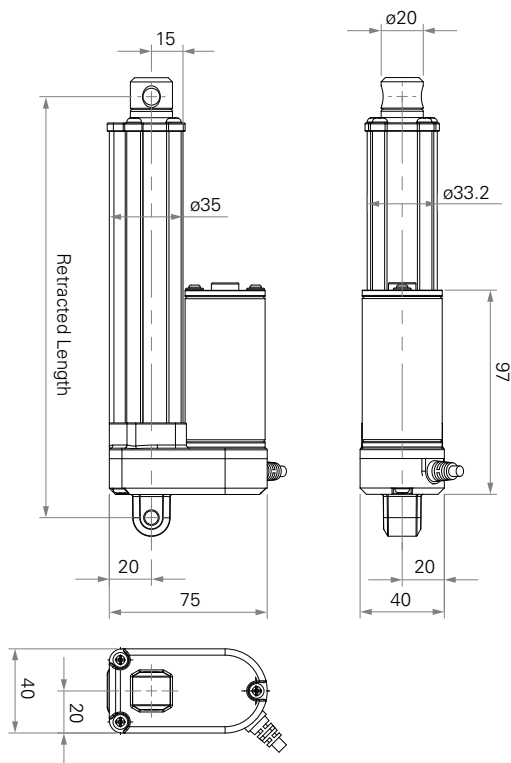

Output Signal
#1, 2, 3, 4, 5

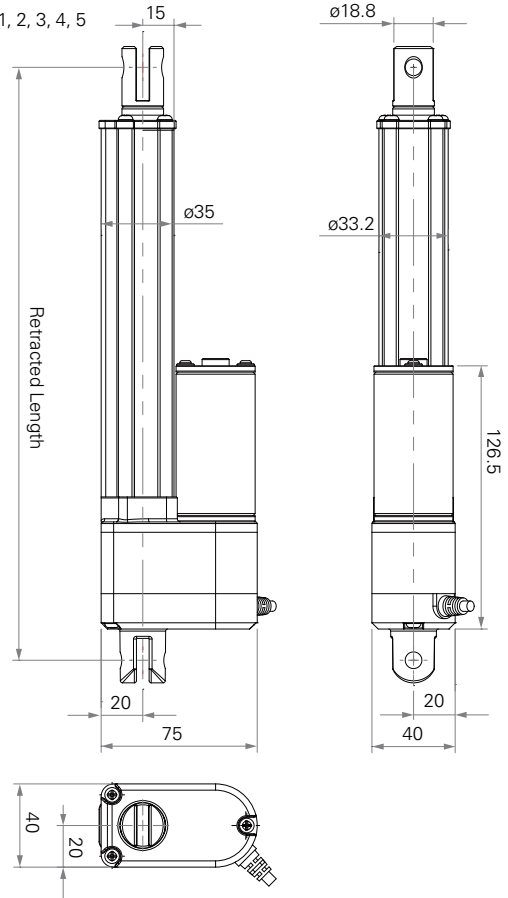

General Features

Maximum load	1,000N in push and pull
Maximum speed at full load	51mm/s (with 120N in a push or pull condition)
Stroke	20~1000mm
Minimum installation dimension	Stroke+105mm (without output signals)
Operational temperature range	Load < 500N: +5°C~+45°C Load ≥ 500N: -25°C~+65°C
Operational temperature range at full performance	+5°C~+45°C
IP rating	Up to IP66D
Options	POT, Reed, Hall sensor(s)
Compact size for limited space	

Performance Data

Motor Speed 4200RPM, Duty Cycle 25%

Speed vs. Thrust

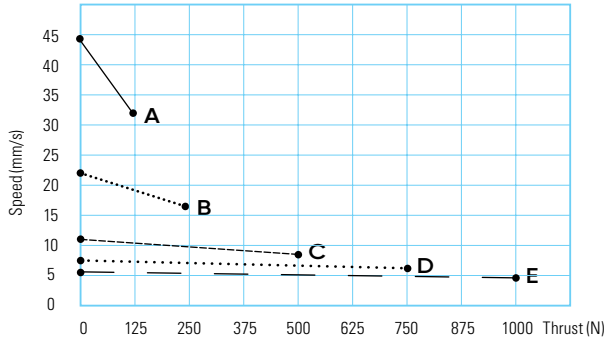

Current vs. Thrust

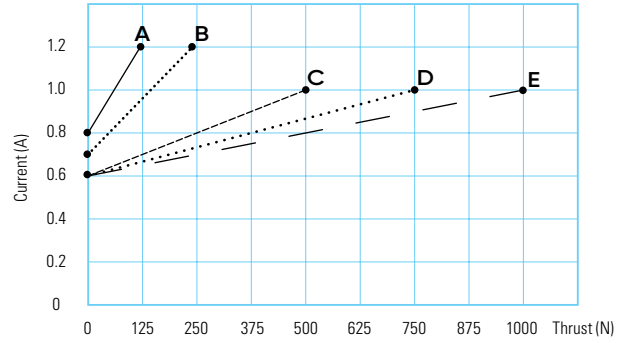

Motor Speed 6000RPM, Duty Cycle 25%

Speed vs. Thrust

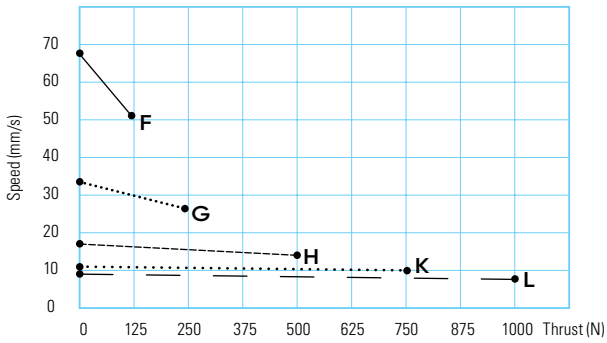

Current vs. Thrust

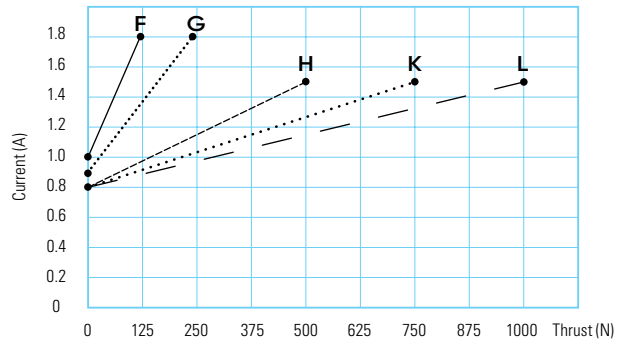

NOTE

1 The performance data in the curve charts shows theoretical value.

TA2 Ordering Key

TA2

Version: 20180517-O

Voltage	1 = 12V DC 2 = 24V DC 3 = 36V DC	4 = 48V DC 5 = 24V DC, PTC 6 = 12V DC, PTC	7 = 36V DC, PTC 8 = 48V DC, PTC
Load and Speed	See page 42		
Stroke (mm)			
Restracted Lengh (mm)	See page 46		
Rear Attachment (mm) See page 48	1 = Aluminum casting, without slot, hole 6.4, one piece casting with gear box 2 = Aluminum casting, without slot, hole 8, one piece casting with gear box 3 = Aluminum casting, without slot, hole 10, one piece casting with gear box 4 = Aluminum casting, clevis U, slot 6, depth 10.5, hole 6.4, one piece casting with gear box 5 = Aluminum casting, clevis U, slot 6, depth 10.5, hole 8, one piece casting with gear box 6 = Aluminum casting, clevis U, slot 6, depth 10.5, hole 10, one piece casting with gear box		
Front Attachment (mm) See page 48	1 = Aluminum casting, without slot, hole 6.4 2 = Aluminum casting, without slot, hole 8 3 = Aluminum CNC, U clevis, slot 6, depth 16, hole 10 4 = Aluminum CNC, U clevis, slot 6, depth 16, hole 6.4 5 = Aluminum CNC, U clevis, slot 6, depth 16, hole 8 6 = Aluminum casting, hole 10		
Direction of Rear Attachment (Counterclockwise)	1 = 90°	2 = 0°	See page 49
Functions for Limit Switches	1 = Two switches at full retracted / extended positions to cut current 2 = Two switches at full retracted / extended positions to cut current + 3rd one in between to send signal 3 = Two switches at full retracted / extended positions to send signal 4 = Two switches at full retracted / extended positions to send signal + 3rd one in between to send signal		
Output Signals	0 = Without 1 = POT	3 = Reed sensor 4 = Hall sensor*1	5 = Hall sensors*2
Connector See page 49	1 = DIN 6P, 90° plug	2 = Tinned leads	
Cable Length (mm)	1 = Straight, 300 2 = Straight, 600	3 = Straight, 1000 B~H = For direct cut system, please contact TiMOTION before making an order	
IP Rating	1 = Without 2 = IP54	3 = IP66 6 = IP66D	

TA2

Ordering Key Appendix

Retracted Length (mm)

1. Calculate $A+B+C = Y$
2. Retracted length needs to \geq Stroke+Y

A. Attachment	Front Attachment Code		Rear Attachment Code	
			1,2,3	4,5,6
	1, 2		+105	+109
	3, 4, 5		+115	+119
B. Stroke (mm)	20~150	-	601~600	+62
	151~200	+2	651~650	+72
	201~250	+2	701~700	+82
	251~300	+2	751~750	+92
	301~350	+12	801~800	+102
	351~400	+22	851~850	+112
	401~450	+32	901~900	+122
	451~500	+42	951~950	+132
	501~550	+52	1001~1000	+142
C. Output Signal	Code			
	0		-	
	1, 2, 3, 4, 5		+30	

Functions for Limit Switches

Wire Definitions

	Pin	CODE			
		1	2	3	4
● Green	1	Extend (VDC+)	Extend (VDC+)	Extend (VDC+)	Extend (VDC+)
● Red	2	N/A	N/A	Common	Common
○ White	3	N/A	Middle switch pinB	Upper limit switch	Upper limit switch
● Black	4	N/A	Middle switch pinA	N/A	Medium limit switch
● Yellow	5	Retract (VDC+)	Retract (VDC+)	Retract (VDC+)	Retract (VDC+)
● Blue	6	N/A	N/A	Lower limit switch	Lower limit switch

NOTE

¹ See ordering key - functions for limit switches.

Rear Attachment (Below is the illustration of 90° rear attachment) (mm)

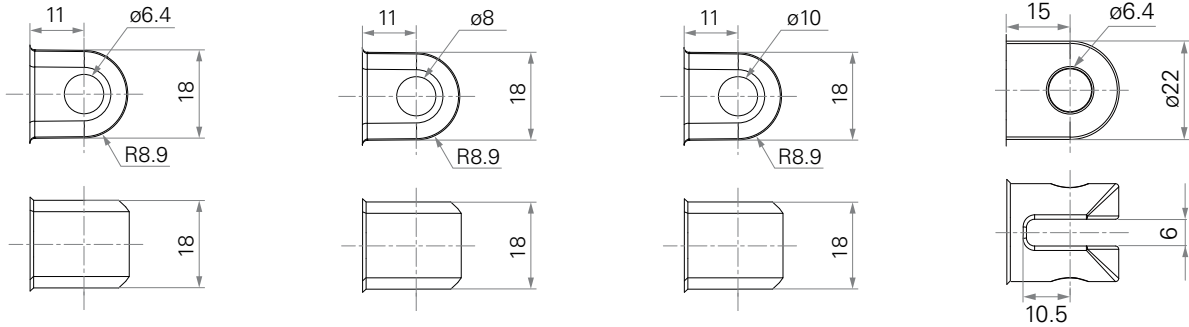

1 = Aluminum casting, without slot, hole 6.4, one piece casting with gear box

2 = Aluminum casting, without slot, hole 8, one piece casting with gear box

3 = Aluminum casting, without slot, hole 10, one piece casting with gear box

4 = Aluminum casting, clevis U, slot 6, depth 10.5, hole 6.4, one piece casting with gear box

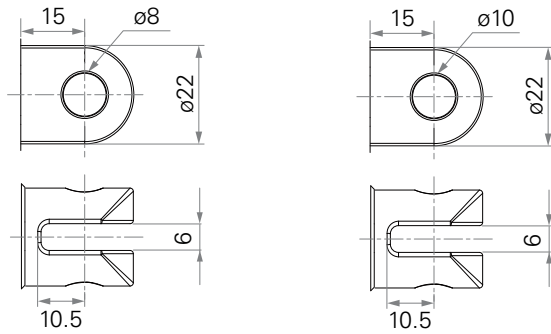

5 = Aluminum casting, clevis U, slot 6, depth 10.5, hole 8, one piece casting with gear box

6 = Aluminum casting, clevis U, slot 6, depth 10.5, hole 10, one piece casting with gear box

Front Attachment (mm)

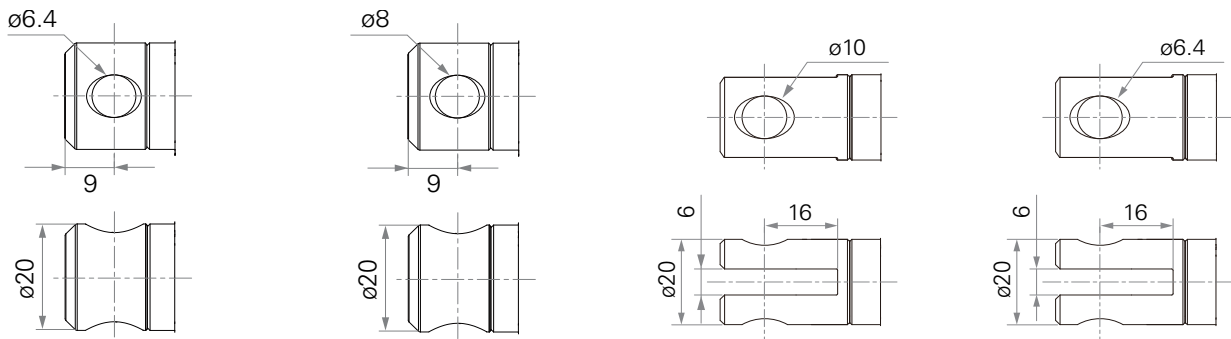

1 = Aluminum casting, without slot, hole 6.4

2 = Aluminum casting, without slot, hole 8

3 = Aluminum CNC, U clevis, slot 6, depth 16.0, hole 10

4 = Aluminum CNC, U clevis, slot 6, depth 16, hole 6.4

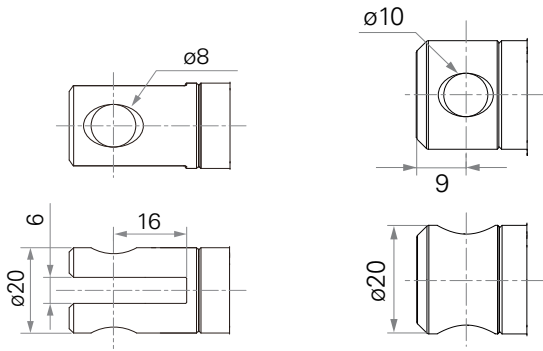

5 = Aluminum CNC, U clevis,
slot 6, depth 16, hole 8

6 = Aluminum casting, without
slot, hole 10

Direction of Rear Attachment Counterclockwise

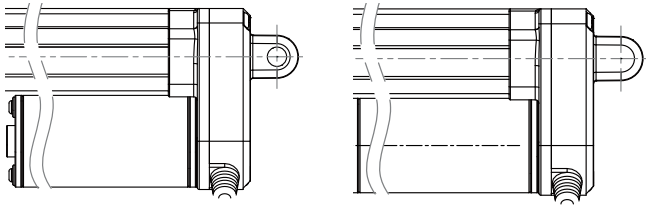

1 = 90°

2 = 0°

Connector



1 = DIN 6P, 90° plug

2 = Tinned leads

TA2P

series



Both the TA2 and the TA2P are compact, robust, and capable of performing well in certain outdoor environments. A more powerful motor makes the TA2P capable of handling load ratings up to 3500N (787 pounds) while retaining its compact size. In addition to the high power motor, the TA2P linear actuator is available with multiple choices for feedback sensors.

Load and Speed

	CODE	Load (N)		Self Locking Force (N)	Typical Current (A)		Typical Speed (mm/s)	
		Push	Pull		No Load 24V DC	With Load 24V DC	No Load 24V DC	With Load 24V DC
Motor Speed (5200RPM)	A	250	250	250	1.2	2.3	43.0	36.0
	B	500	500	500	1.1	2.3	25.8	23.0
	C	1000	1000	1000	1.1	2.3	14.0	11.8
	D	1500	1500	1500	1.0	2.2	9.0	8.0
	E	2000	2000	2000	1.0	2.2	7.1	6.2
Motor Speed (6600RPM)	F	250	250	250	1.6	2.8	56.5	45.0
	G	500	500	500	1.5	2.8	32.5	28.5
	H	1000	1000	1000	1.5	2.8	16.5	14.3
	K	1500	1500	1500	1.3	2.8	11.1	10.0
	L	2000	2000	2000	1.3	2.8	8.8	7.7
Motor Speed (3800RPM)	S	3500	2000	3500	0.9	2.8	3.2	2.4
Motor Speed (2200RPM)	T	2000	2000	2000	0.3	1.2	3.2	2.4

NOTE

- 1 Motor 12V current is around 2 times in 24V; Motor 36V current is around 2/3 in 24V; Motor 48V current is around 1/2 in 24V; speed is around the same.
- 2 Above self lock performance needs working with Timotion control system in push direction.
- 3 Please refer to the approved drawing for the final authentic value.

Standard Dimension (mm)

Without
Output Signal

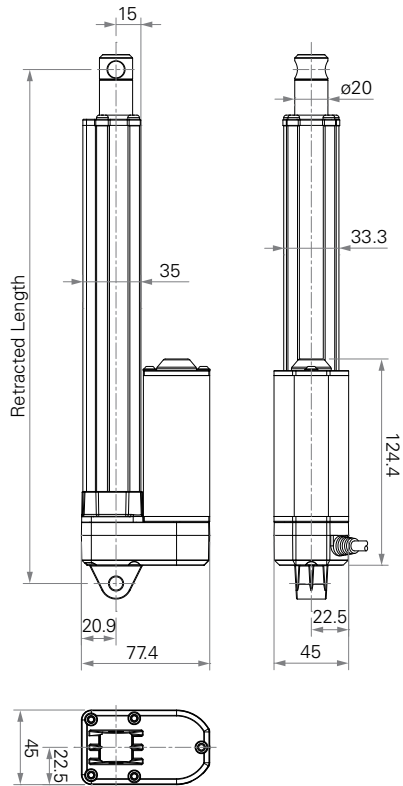

Output Signal
#1, 2, 3, 4, 5

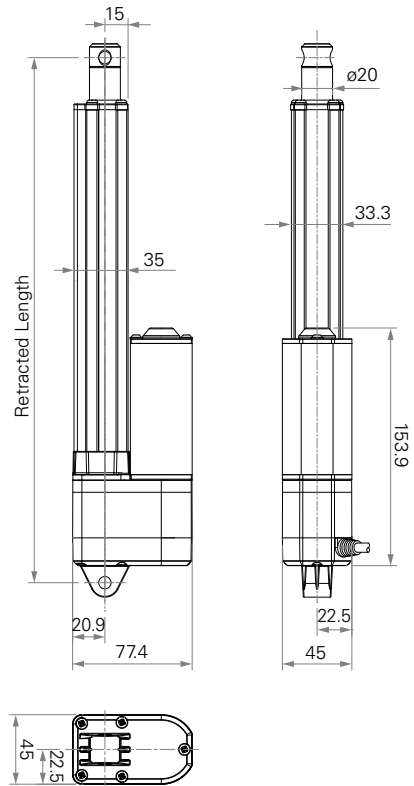

General Features

Maximum load	3,500N in push
Maximum load	2,000N in pull
Maximum speed at full load	45mm/s (with 250N in a push or pull condition)
Stroke	20~1000mm
Minimum installation dimension	Stroke+108mm (without Hall sensor(s) or without output signals)
IP rating	Up to IP66D
Operational temperature range	-25°C~+65°C
Operational temperature range at full performance	+5°C~+45°C
Options	POT, Optical, or Hall/Reed sensor(s)

Performance Data

Motor Speed 5200RPM, Duty Cycle 25%

Speed vs. Thrust

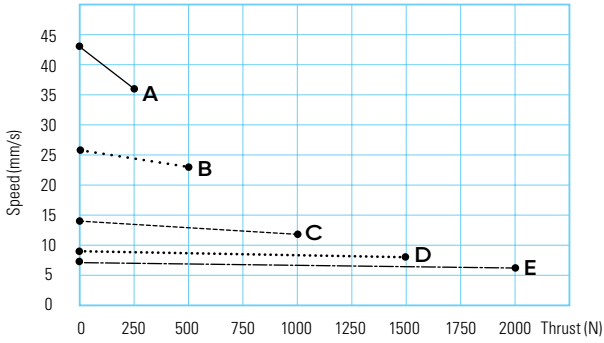

Current vs. Thrust

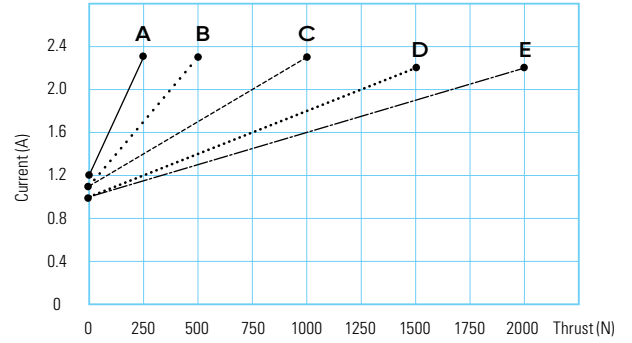

Motor Speed 6600RPM, Duty Cycle 25%

Speed vs. Thrust

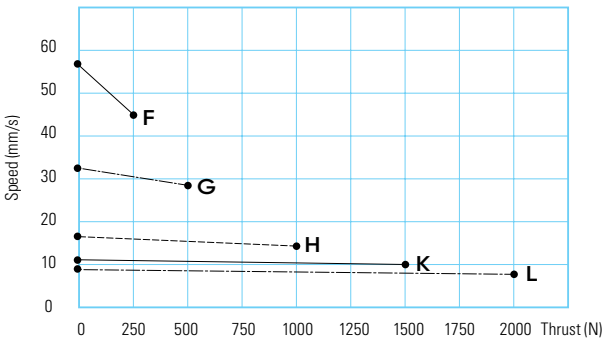

Current vs. Thrust

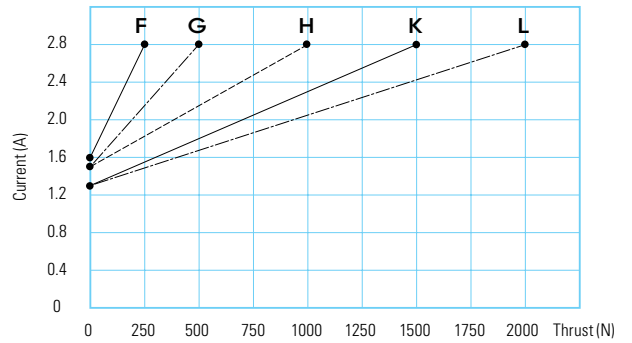

NOTE

1 The performance data in the curve charts shows theoretical value.

Performance Data

Motor Speed 3800RPM, Duty Cycle 25%

Speed vs. Thrust

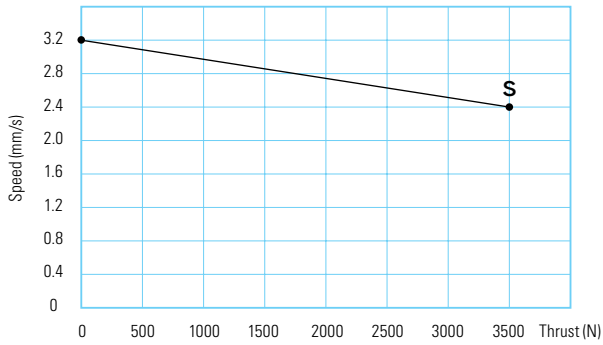

Current vs. Thrust

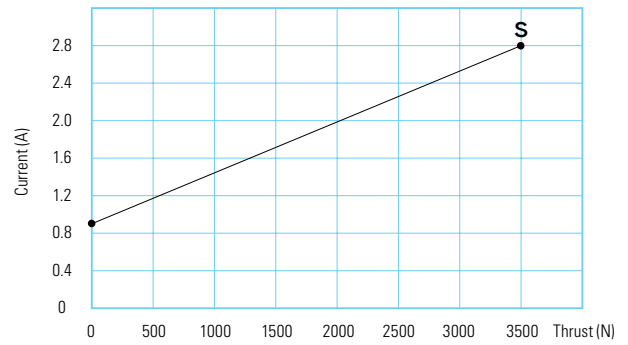

Motor Speed 2200RPM, Duty Cycle 25%

Speed vs. Thrust

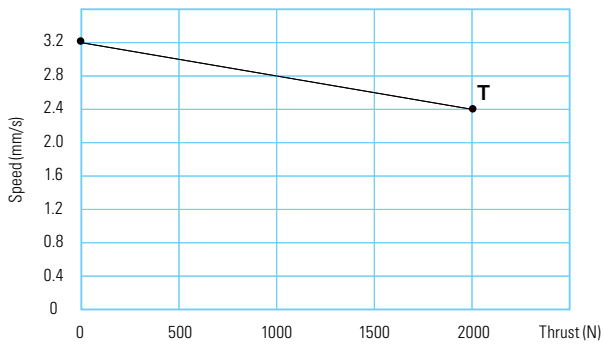

Current vs. Thrust

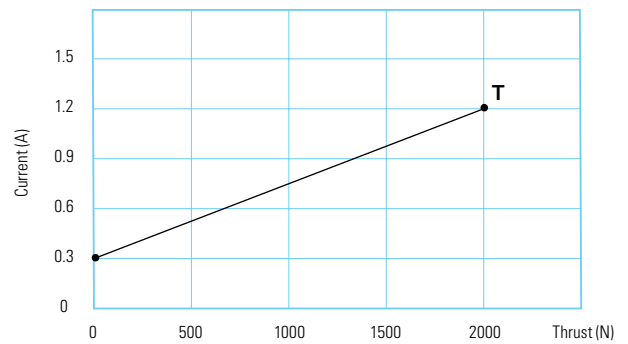

NOTE

1 The performance data in the curve charts shows theoretical value.

TA2P Ordering Key

TA2P

Version: 20171127-M

Voltage	1 = 12V DC 2 = 24V DC	3 = 36V DC 5 = 24V DC, PTC	6 = 12V DC, PTC
Load and Speed	See page 50		
Stroke (mm)			
Restracted Length (mm)	See page 55		
Rear Attachment (mm) See page 57	1 = Aluminum casting, hole 6.4, one piece casting with gear box 2 = Aluminum casting, hole 8, one piece casting with gear box 3 = Aluminum casting, hole 10, one piece casting with gear box 4 = Aluminum casting, U clevis, slot 6, depth 10.5, hole 6.4, one piece casting with gear box 5 = Aluminum casting, U clevis, slot 6, depth 10.5, hole 8, one piece casting with gear box 6 = Aluminum casting, U clevis, slot 6, depth 10.5, hole 10, one piece casting with gear box		
Front Attachment (mm) See page 57	1 = Aluminum casting, no slot, hole 6.4 2 = Aluminum casting, no slot, hole 8 3 = Aluminum CNC, U clevis, slot 6, depth 16, hole 10 4 = Aluminum CNC, U clevis, slot 6, depth 16, hole 6.4 5 = Aluminum CNC, U clevis, slot 6, depth 16, hole 8		
Direction of Rear Attachment (Counterclockwise)	1 = 90° See page 58	2 = 0°	
Functions for Limit Switches	1 = Two switches at full retracted / extended positions to cut current 2 = Two switches at full retracted / extended positions to cut current+3rd one in between to send signal 3 = Two switches at full retracted / extended positions to send signal 4 = Two switches at full retracted / extended positions to send signal+3rd one in between to send signal		
Output Signals	0 = Without 1 = POT	2 = Optical 3 = Reed sensor	4 = Hall sensor*1 5 = Hall sensors*2
Connector See page 58	1 = DIN 6P, 90° plug	2 = Tinned leads	
Cable Length (mm)	1 = Straight, 300 2 = Straight, 600	3 = Straight, 1000 B~H = For direct cut system, please contact TiMOTION before making an order	
IP Rating	1 = Without 2 = IP54	3 = IP66 6 = IP66D	

TA2P

Ordering Key Appendix

Retracted Length (mm)

1. Calculate $A+B+C = Y$
2. Retracted length needs to \geq Stroke+Y

A. Attachment	Front Attachment Code	Rear Attachment Code	
		1,2,3	4,5,6
	1, 2	+108	+112
	3, 4, 5	+120	+124

B. Stroke (mm)	Load (N)	
	<3500	=3500
0~150	-	+5
151~200	+2	+7
201~250	+2	+7
251~300	+2	+7
301~350	+12	+17
351~400	+22	+27
401~450	+32	+37
451~500	+42	+47
501~550	+52	+57
551~600	+62	+67
601~650	+72	+77
651~700	+82	+87
701~750	+92	+97
751~800	+102	+107
801~850	+112	+117
851~900	+122	+127
901~950	+132	+137
951~1000	+142	+147

C. Output Signal	Code	
	0, 4, 5	-
1, 2, 3	+30	

Functions for Limit Switches

Wire Definitions

	Pin	CODE			
		1	2	3	4
● Green	1	Extend (VDC+)	Extend (VDC+)	Extend (VDC+)	Extend (VDC+)
● Red	2	N/A	N/A	Common	Common
○ White	3	N/A	Middle switch pinB	Upper limit switch	Upper limit switch
● Black	4	N/A	Middle switch pinA	N/A	Medium limit switch
● Yellow	5	Retract (VDC+)	Retract (VDC+)	Retract (VDC+)	Retract (VDC+)
● Blue	6	N/A	N/A	Lower limit switch	Lower limit switch

NOTE

2 See ordering key - functions for limit switches.

Rear Attachment (mm)

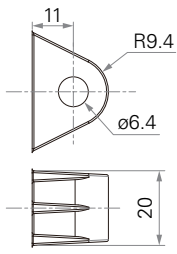

1 = Aluminum casting, hole 6.4, one piece casting with gear box

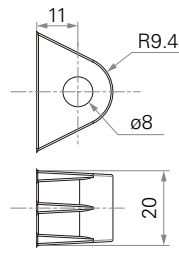

2 = Aluminum casting, hole 8, one piece casting with gear box

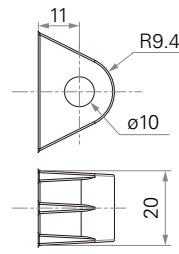

3 = Aluminum casting, hole 10, one piece casting with gear box

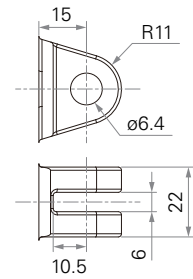

4 = Aluminum casting, clevis U, slot 6, depth 10.5, hole 6.4, one piece casting with gear box

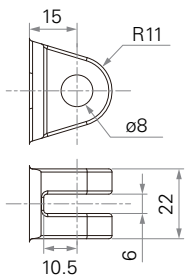

5 = Aluminum casting, clevis U, slot 6, depth 10.5, hole 8, one piece casting with gear box

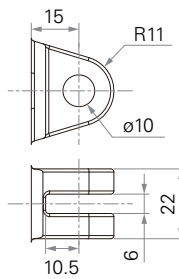

6 = Aluminum casting, clevis U, slot 6, depth 10.5, hole 10, one piece casting with gear box

Front Attachment (mm)

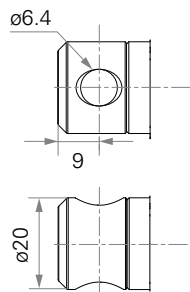

1 = Aluminum casting, no slot, hole 6.4

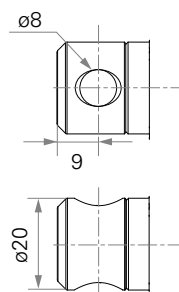

2 = Aluminum casting, no slot, hole 8

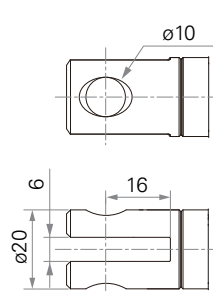

3 = Aluminum CNC, U clevis, slot 6, depth 16, hole 10

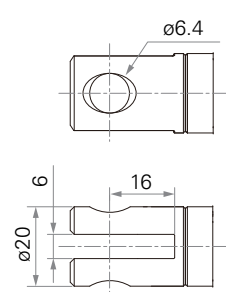

4 = Aluminum CNC, U clevis, slot 6, depth 16, hole 6.4

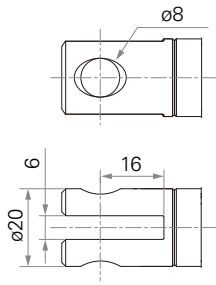

5 = Aluminum CNC, U clevis,
slot 6, depth 16, hole 8

Direction of Rear Attachment Counterclockwise

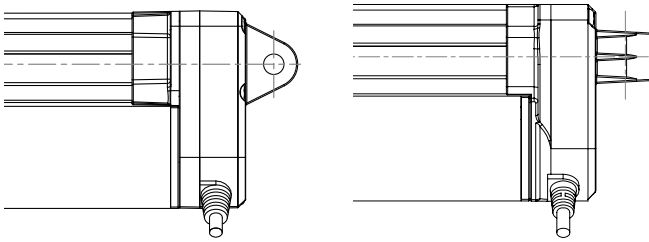

1 = 90°

2 = 0°

Connector

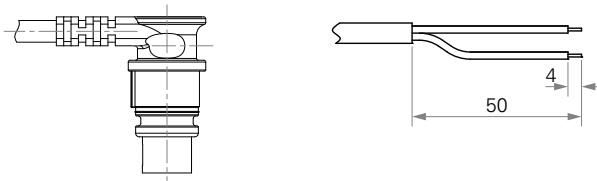

1 = DIN 6P, 90° plug

2 = Tinned leads



TA16 series



TiMOTION's TA16 series linear actuator is similar to the TA2 linear actuator, but is specifically designed for low-noise industrial applications where a compact linear actuator is needed. It is available with optional IP66 protection and Hall sensors for position feedback.

Load and Speed

	CODE	Load (N)		Self Locking Force (N)	Typical Current (A)		Typical Speed (mm/s)	
		Push	Pull		No Load 24V DC	With Load 24V DC	No Load 24V DC	With Load 24V DC
Motor Speed (3800RPM)	A	2500	2500	2500	1.2	2.8	5.2	3.0
	B	2000	2000	2000	1.2	2.8	8.3	4.7
	C	1500	1500	1000	1.2	2.8	11.9	7.0
	D	1000	1000	1000	1.2	2.8	17.7	10.3
Motor Speed (5600RPM)	G	3500	3500	2000	1.5	4.7	12.0	6.5
	J	2000	2000	1000	1.5	3.2	17.0	10.5
	K	1500	1500	700	1.5	3.5	23.5	13.5

NOTE

- 1 With a 12V motor, the current is approximately twice the current measured in 24V; speed will be similar for both voltages.
- 2 This self-locking force level is reached only when a short circuit is applied on the terminals of the motor. All the TiMOTION control boxes have this feature built-in.
- 3 Current and speed: Tested average value when extending in push direction.
- 4 Please refer to the approved drawing for the final authentic value.

Standard Dimension (mm)

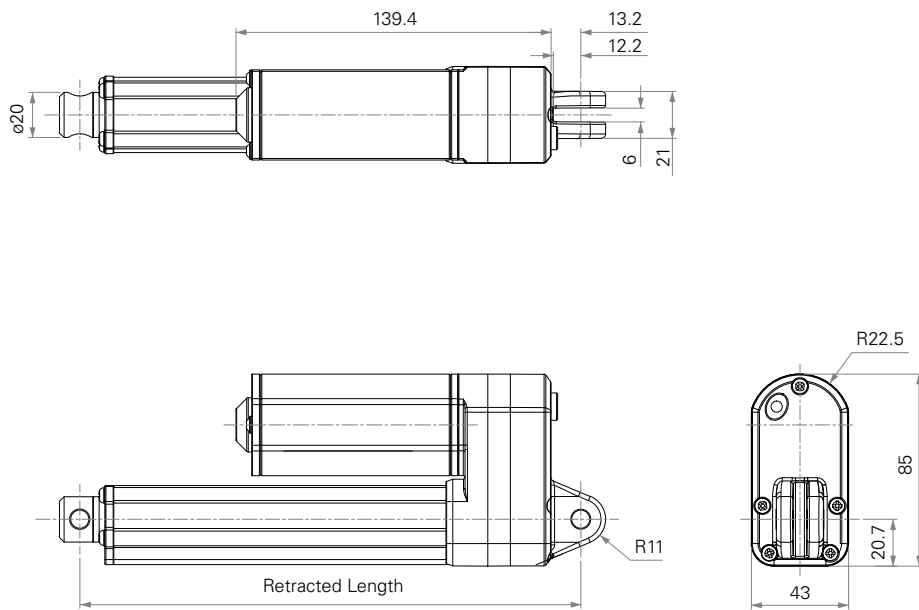

General Features

Maximum load	3,500N in push and pull
Maximum speed at full load	13.5 mm/s (with 1500N in a push or pull condition)
Stroke	20~600mm
Minimum installation dimension	Stroke+112mm
IP rating	Up to IP66
Operational temperature range	+5°C~+45°C
Options	POT, Hall sensor(s)
With very low noise, small size for easy installation	

Performance Data

Motor Speed 3800RPM, Duty Cycle 10%

Speed vs. Thrust

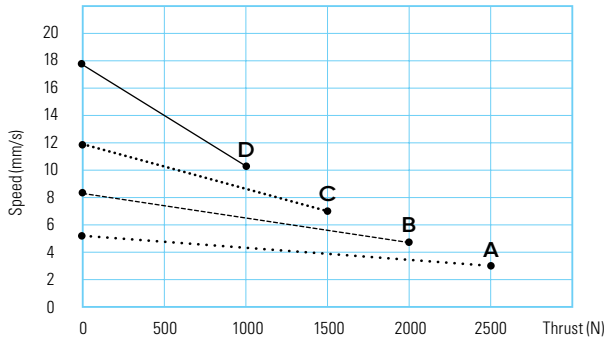

Current vs. Thrust

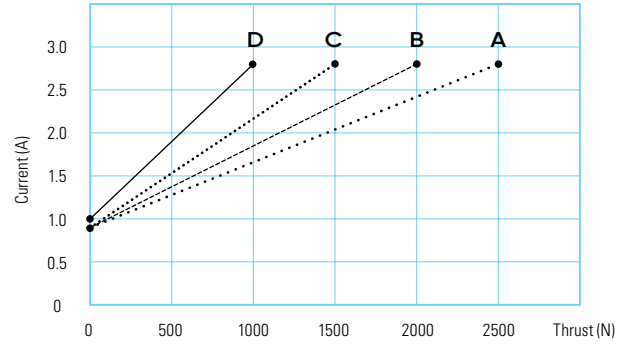

Motor Speed 5600RPM, Duty Cycle 10%

Speed vs. Thrust

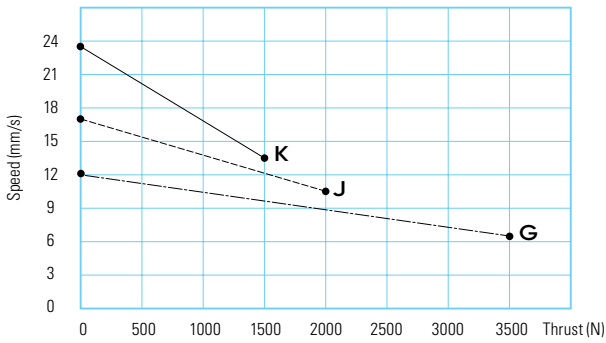

Current vs. Thrust

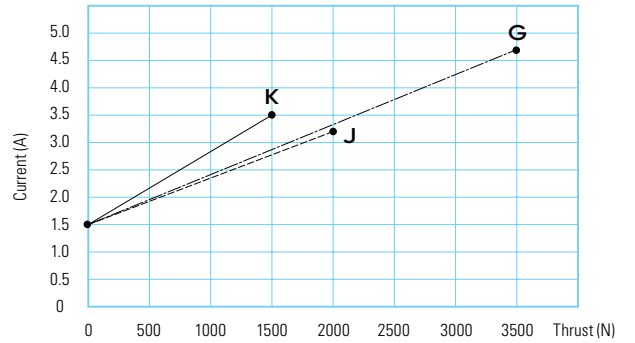

NOTE

1 The performance data in the curve charts shows theoretical value.

TA16 Ordering Key

TA16

Version: 20160605-H

Voltage	1 = 12V DC	2 = 24V DC	
Load and Speed	See page 60		
Stroke (mm)			
Restracted Length (mm)	See page 64		
Rear Attachment (mm) See page 66	1 = Aluminum casting, U clevis, width 6, depth 12.2, hole 6.4, one piece casting with gear box 2 = Aluminum casting, U clevis, width 6, depth 12.2, hole 8, one piece casting with gear box 3 = Aluminum casting, U clevis, width 6, depth 12.2, hole 10, one piece casting with gear box		
Front Attachment (mm) See page 66	1 = Aluminum casting, no slot, hole 6.4 2 = Aluminum casting, no slot, hole 8 3 = Aluminum casting, no slot, hole 10 4 = Aluminum casting, U clevis, width 6, depth 13, hole 6.4 5 = Aluminum casting, U clevis, width 6, depth 13, hole 8 6 = Aluminum casting, U clevis, width 6, depth 13, hole 10		
Direction of Rear Attachment (Counterclockwise)	1 = 90°	2 = 0°	
IP Rating	1 = Without	2 = IP54	3 = IP66
Functions for Limit Switches	1 = Two switches at full retracted/extended positions to cut current 2 = Two switches at full retracted/extended positions to cut current + 3rd LS to send signal 3 = Two switches at full retracted/extended positions to send signal 4 = Two switches at full retracted/extended positions to send signal + 3rd LS to send signal		
Special Functions for Spindle Sub-Assembly	0 = Without	2 = Standard push only	
	1 = Safety nut	3 = Standard push only + safety nut	
Output Signals	0 = Without	4 = Hall sensor*1	
	1 = POT	5 = Hall sensors*2	
Connector See page 67	1 = DIN 6P, 90° plug	C = Y cable (For direct cut system, water proof, anti pull)	E = Molex 8P, plug
	2 = Tinned leads		F = DIN 6P, 180° plug
	4 = Big 01P, plug		G = Audio plug
Cable Length (mm)	0 = Straight, 100	4 = Straight, 1250	8 = Curly, 400
	1 = Straight, 500	5 = Straight, 1500	B~H = For direct cut system, please contact TiMOTION before making an order
	2 = Straight, 750	6 = Straight, 200	
	3 = Straight, 1000	7 = Curly, 20	

TA16

Ordering Key Appendix

Retracted Length (mm)

1. Calculate $A+B+C = Y$
2. Retracted length needs to \geq Stroke+Y

A. Attachment	Front Attachment Code		Rear Attachment Code	
			1, 2, 3	
	1, 2, 3		+112	
	4, 5, 6		+122	

B. Stroke (mm)	Load (N)		
		<3500	=3500
~150	-	-	+5
151~200	+8	+8	+13
201~250	+8	+8	+13
251~300	+13	+13	+18
301~350	+13	+13	+18
351~400	+18	+18	+23
401~450	+23	+23	+28
451~500	+28	+28	+33
501~550	+33	+33	+38
551~600	+38	+38	+43

C. Spindle Sub	Load (N)		
	A, B	G	C, D, J, K
0	-	-	-
1	+10	-	-
2	+2	+2	+2
3	+12	-	-

D. Output Signal	CODE	
	0, 4, 5	-
	1	+36

Functions for Limit Switches

Wire Definitions

		Pin	CODE			
			1	2	3	4
● Green		1	Extend (VDC+)	Extend (VDC+)	Extend (VDC+)	Extend (VDC+)
● Red		2	N/A	N/A	Common	Common
○ White		3	N/A	Middle switch pinB	Upper limit switch	Upper limit switch
● Black		4	N/A	Middle switch pinA	N/A	Medium limit switch
● Yellow		5	Retract (VDC+)	Retract (VDC+)	Retract (VDC+)	Retract (VDC+)
● Blue		6	N/A	N/A	Lower limit switch	Lower limit switch

NOTE

¹ See ordering key - functions for limit switches.

Rear Attachment (mm)

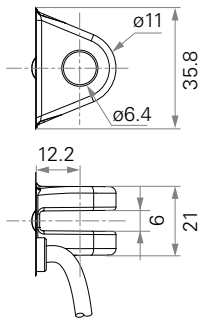

1 = Aluminum casting, U clevis, width 6, depth 12.2, hole 6.4, one piece casting with gear box

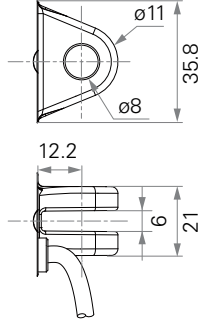

2 = Aluminum casting, U clevis, width 6, depth 12.2, hole 8, one piece casting with gear box

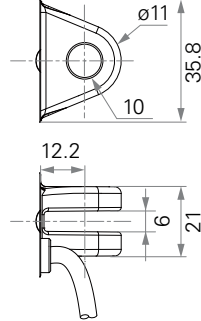

3 = Aluminum casting, U clevis, width 6, depth 12.2, hole 10, one piece casting with gear box

Front Attachment (mm)

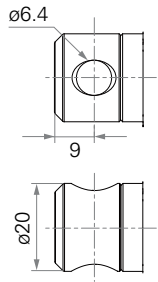

1 = Aluminum casting, no slot, hole 6.4

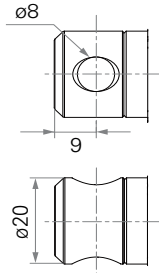

2 = Aluminum casting, no slot, hole 8

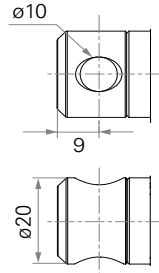

3 = Aluminum casting, no slot, hole 10

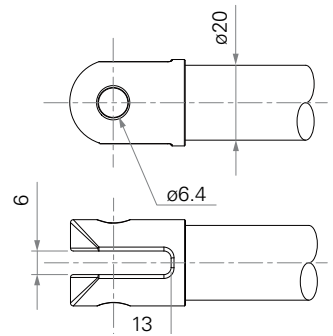

4 = Aluminum casting, U clevis, width 6, depth 13, hole 6.4

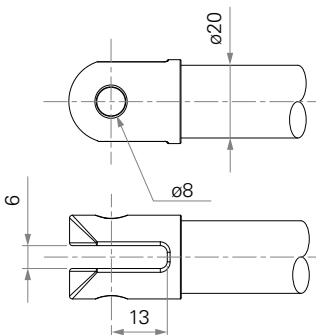

5 = Aluminum casting, U clevis, width 6, depth 13, hole 8

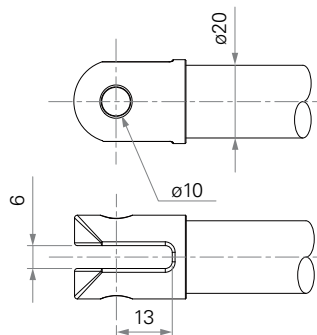

6 = Aluminum casting, U clevis, width 6, depth 13, hole 10

Direction of Rear Attachment

Counterclockwise

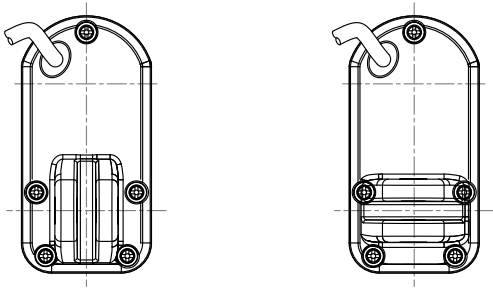

1 = 90°

2 = 0°

Connector

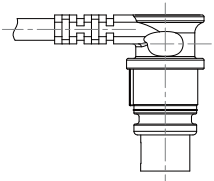

1 = DIN 6P, 90° plug

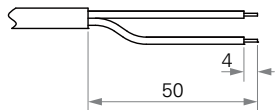

2 = Tinned leads

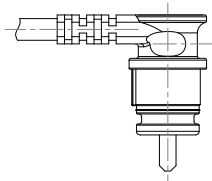

4 = Big 01P, plug

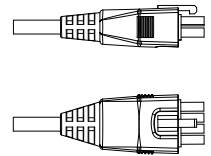

E = Molex 8P, plug

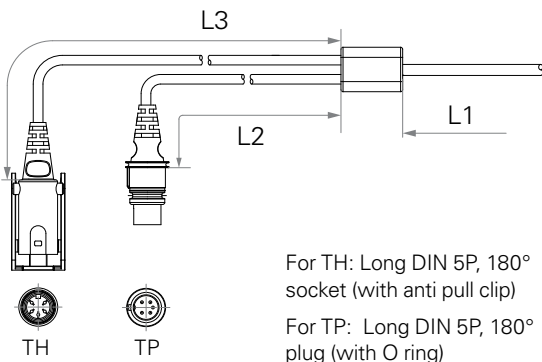

TH

TP



F = DIN 6P, 180° plug

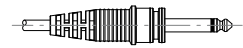

G = Audio plug

C = Y cable, for direct cut system

Cable length for direct cut system (mm)

Code	L1	L2	L3
C	100	1000	400

TA21

series

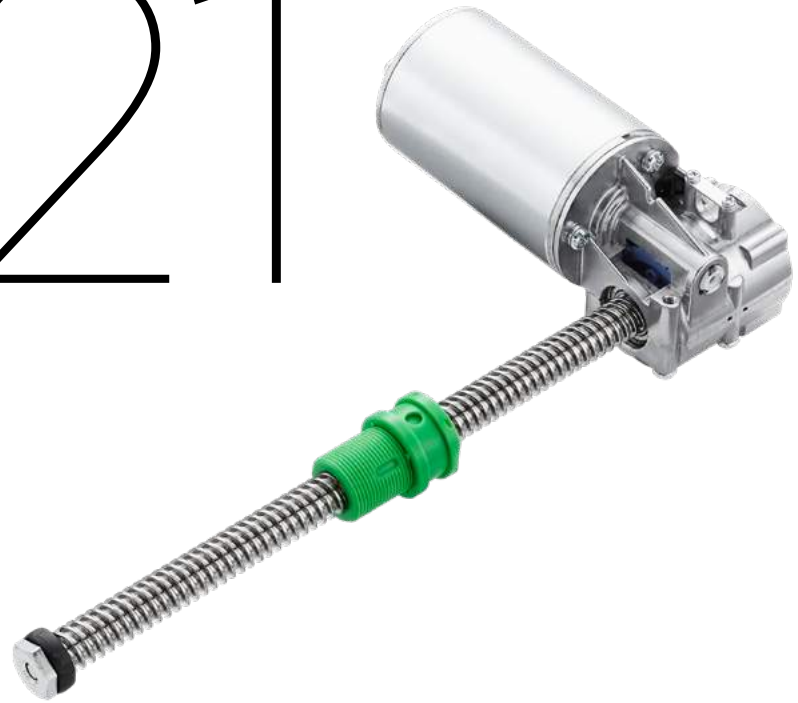

TiMOTION's TA21 electric linear actuator was designed for use in height adjustable industrial workstations. Customers have a high degree of design flexibility with this actuator as it does not include a standard outer tube. This allows manufacturers to decide on the exact aesthetic and ingress specifications for their electric lifting column and overall application

Load and Speed

	CODE	Load (N)		Typical Current (A)		Typical Speed (mm/s)	
		Push	Pull	No Load 24V DC	With Load 24V DC	No Load 24V DC	With Load 24V DC
Motor Speed (3800RPM)	A	10000	6000	2.0	15.0	16.1	6.3
	C	7000	6000	2.0	9.0	16.4	8.3
	D	4000	4000	2.0	9.5	32.9	16.2

NOTE

- 1 Self locking force: Tested average value when working with TiMOTION control system.
- 2 Operational temperature range: +5°C~+45°C.
- 3 Please refer to the approved drawing for the final authentic value.

Standard Dimension (mm)

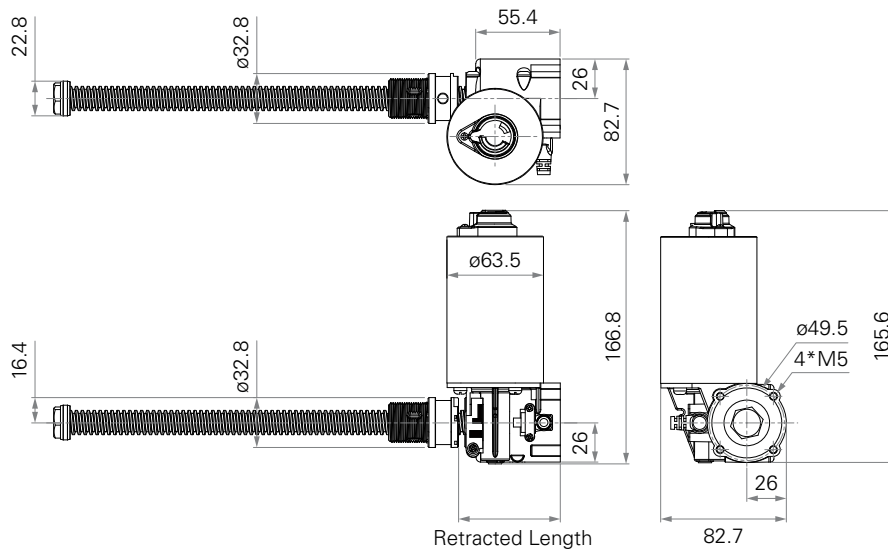

General Features

Maximum load	10,000N in push
Maximum load	6,000N in pull
Maximum speed at full load	16.2mm/s (with 4000N in a push or pull condition)
Motor Cable Color	Black or grey
Options	Safety nut, Hall/ Reed sensor(s)

Performance Data

Motor Speed 3800RPM, Duty Cycle 10%

Speed vs. Thrust

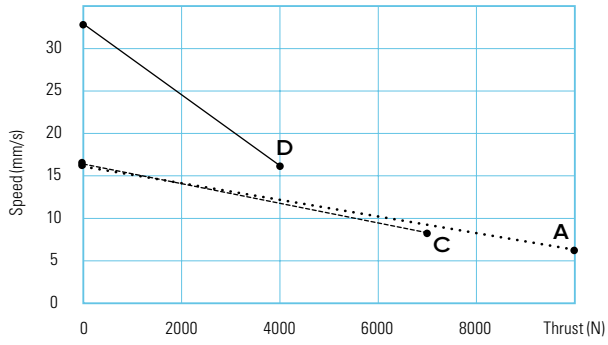

Current vs. Thrust

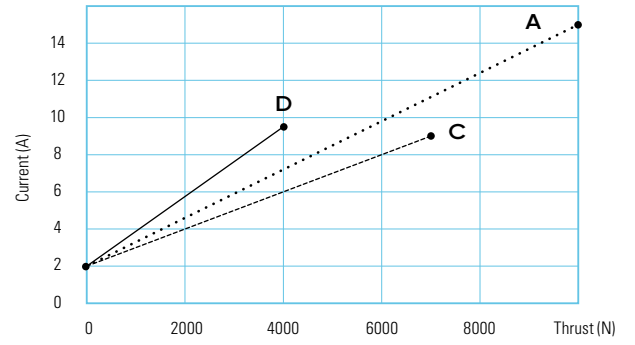

NOTE

1 The performance data in the curve charts shows theoretical value.

TA21 Ordering Key

TA21

Version: 20180314-B

Voltage	2 = 24V DC		
Load and Speed	See page 68		
Stroke (mm)			
Restracted Lengh (mm)	See page 69		
Motor Cable Color	1 = Black	2 = Grey (Pantone 428C)	
Special Functions for Spindle Sub-Assembly	1 = Safety nut		
Signal Output	0 = Without	2 = Hall sensors*2	3 = Reed sensor
Connector See page 72	1 = DIN 6P, 90° plug	2 = Tinned leads	F = DIN 6P, 180° plug
Cable Length (mm)	1= Straight, 500 2= Straight, 750 3= Straight, 1000	4= Straight, 1250 5= Straight, 1500 6= Straight, 2000	7= Curly, 200 8= Curly, 400

Connector

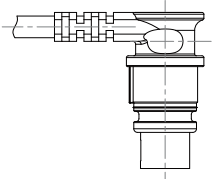

1 = DIN 6P, 90° plug

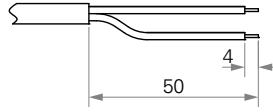

2 = Tinned leads

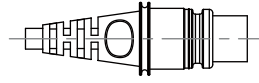

F = DIN 6P, 180° plug



TGM1

series



TiMOTION's TGM1 series gear motor was designed primarily for ergonomic applications like height adjustable workstations and tables, but can be used in many other applications. This economical product allows for fast, smooth and quiet adjustment of built-in spindles through the use of external limit switches. Shafting allows for the mechanical synchronization of dual spindles.

Load and Speed

	CODE	Rated Torque (Nm)	Self Locking Force (Nm)		Typical Current (A)		Typical Speed (RPM±5%)	
			Brake #0	Brake #1	No Load 24V DC	With Load 24V DC	No Load 24V DC	With Load 24V DC
Motor Speed (3800RPM)	A	7.6	1.4	4.4	1.0	5.0	132	72
	D	3.8	0.2	1.9	1.0	5.0	264	144
Motor Speed (3400RPM)	B	7.7	1.4	4.4	1.0	4.0	112	64
	E	3.9	0.2	1.9	1.0	4.0	224	128
Motor Speed (2600RPM)	C	6.8	1.4	4.4	1.0	3.0	88	51
	F	3.4	0.2	1.9	1.0	3.0	175	102

NOTE

1 Please refer to the approved drawing for the final authentic value.

Standard Dimension (mm)

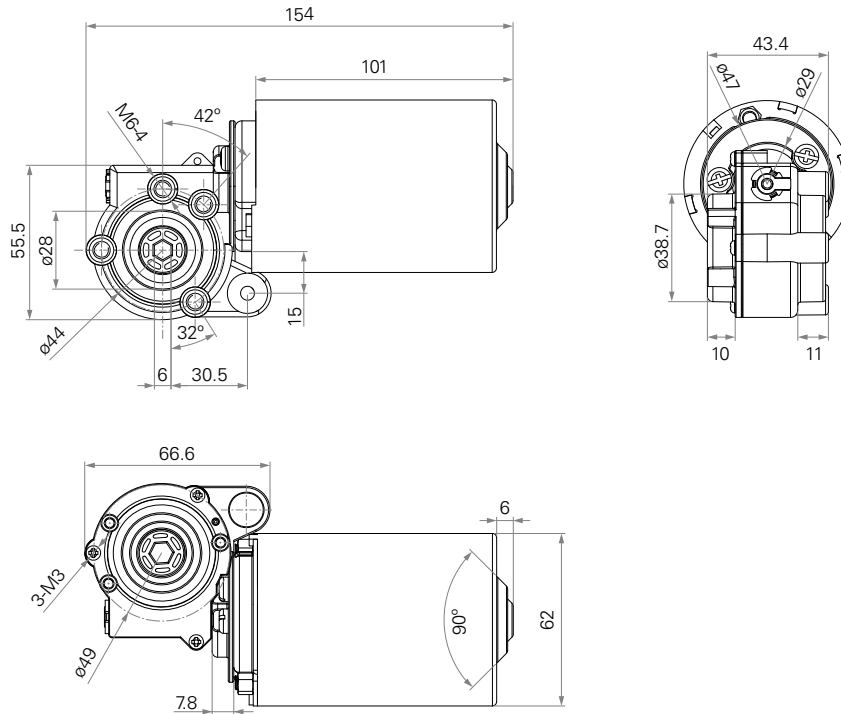

General Features

Voltage of motor	24V DC or 24V DC, PTC
Maximum speed at full load	144RPM ($\pm 5\%$) after gear reduction
Maximum rated torque	7.7Nm
Operational temperature range at full performance	+5°C~+45°C
Options	Hall sensor(s)
Hexagon hole for the shaft by 6mm diameter	
Low noise	

TGM1 Ordering Key

TGM1

Version: 20170520-H

Voltage	2 = 24V DC	5 = 24V DC, PTC
Load and Speed	See page 74	
Output Signal	0 = Without	1 = Hall sensor*1 2 = Hall sensors*2
Brake	0 = Without	1 = Motor brake
Connector	0 = Tinned leads	1 = DIN 6P, 90° plug 2 = Molex 8P, plug
Cable Length (mm)	0 = Straight, 1000 1 = Straight, 1500	2 = Straight, 2000 3 = Curly, 1000
External Limit Switches (TES2)	00 = Without	XX = Number of output rotations (between 13~17 & 25~35 rotations, factory preset)

TGM2

series



The TGM2 series is TiMOTION's most powerful gear motor. It was designed primarily for ergonomic applications like height adjustable workstations and tables, but can be used in many other applications. This economical product allows for fast, smooth and quiet adjustment of built-in spindles through the use of external limit switches. Shafting allows for the mechanical synchronization of dual spindles.

Load and Speed

	CODE	Rated Torque (Nm)	Self Locking Force (Nm)		Typical Current (A)		Typical Speed (RPM±5%)	
			Brake #0	Brake #1	No Load 24V DC	With Load 24V DC	No Load 24V DC	With Load 24V DC
Motor Speed (3800RPM)	A	16.0	5	11	1.5	8.5	110	49
Motor Speed (2200RPM)	B	13.4	5	11	1.5	4.0	62	31

NOTE

1 Please refer to the approved drawing for the final authentic value.

Standard Dimension (mm)

Shaft Selection1
Drive shaft hole
(inner hexagon 9mm)

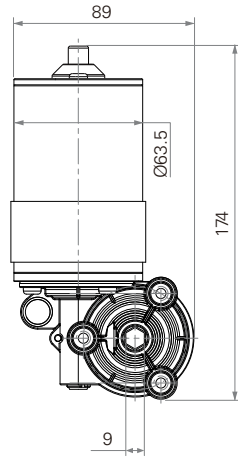

Shaft Selection2
One side drive shaft
(Ø12mm, knurling)

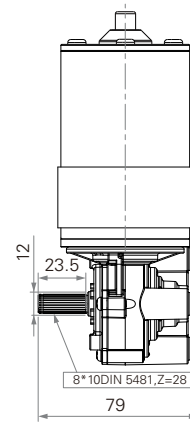

Shaft Selection3
Two sides drive shaft
(Ø12mm, knurling)

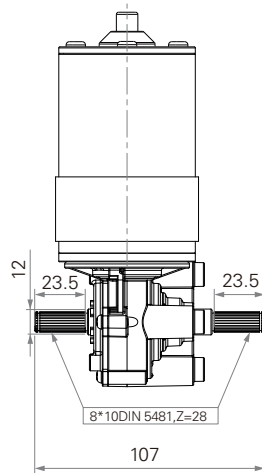

Shaft Selection4
Two sides drive shaft
(Ø12mm, with Ø4.8mm
latch hole)

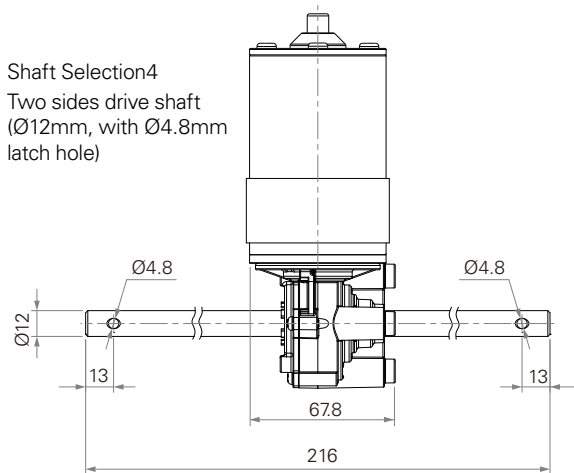

General Features

Voltage of motor	24V DC
Maximum speed at full load	49RPM (±5%) after gear reduction
Maximum rated torque	16Nm
Operational temperature range at full performance	+5°C~+45°C
Options	Hall sensor(s)
Hexagon hole for the shaft by 9mm diameter	
Low noise	

TGM2 Ordering Key

TGM2

Version: 20170520-H

Voltage	5 = 24V DC, thermal protector		
Load and Speed	See page 77		
Output Signal	0 = Without	1 = Hall sensor*1	2 = Hall sensor*2
Brake	0 = Without	1 = Motor brake	
Connector	0 = Tinned leads	1 = DIN 6P, 90° plug	2 = Molex 8P, plug
Cable Length (mm)	0 = Straight, 1000 1 = Straight, 1500	2 = Straight, 2000 3 = Curly, 1000	
Torque Output	1 = Drive shaft hole (Inner hexagon 9mm) 2 = One side drive shaft (Ø12mm, knurling) 3 = Two sides drive shaft (Ø12mm, knurling)	4 = Two sides drive shaft (Ø12mm, with Ø4.8 latch hole)	
External Limit Switches (TES2)	00 = Without	XX = Number of output rotations (Between 13~17 & 25~35 rotations, factory preset)	

TGM3

series

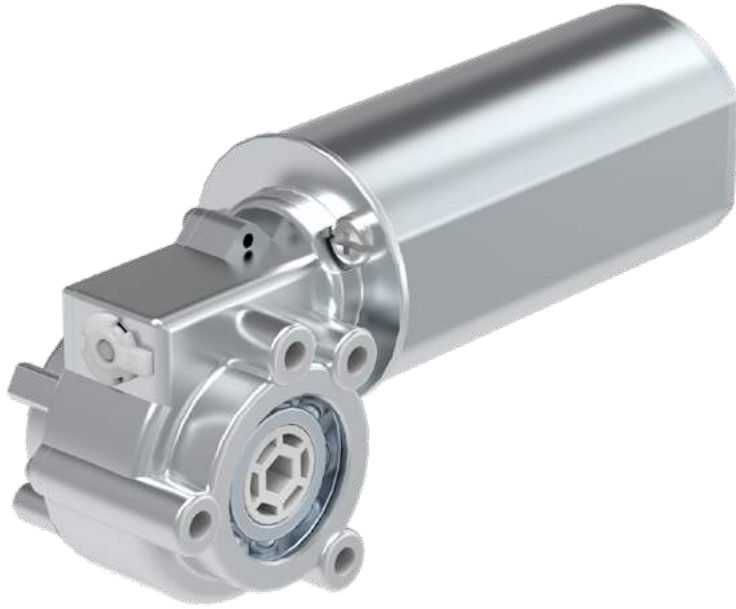

The TGM3 series is TiMOTION's compact size gear motor. It was designed primarily for ergonomic applications like height adjustable workstations and tables, but can be used in many other applications. This economical product allows for fast, smooth and quiet adjustment of built-in spindles through the use of external limit switches. Shafting allows for the mechanical synchronization of dual spindles.

Load and Speed

CODE	Rated Torque (Nm)	Self Locking Force (N)	Typical Current (A)		Typical Speed (RPM±5%)		
			No Load 24V DC	With Load 24V DC	No Load 24V DC	With Load 24V DC	
Motor Speed (3800RPM)	A	4.6	1.7	1.0	3.2	132	52
	C	2.3	0.2	1.0	3.2	264	105
Motor Speed (2200RPM)	B	3.7	1.7	0.8	1.6	79	26
	D	1.9	0.2	0.8	1.6	157	52

NOTE

1 Please refer to the approved drawing for the final authentic value.

Standard Dimension (mm)

Without TES2

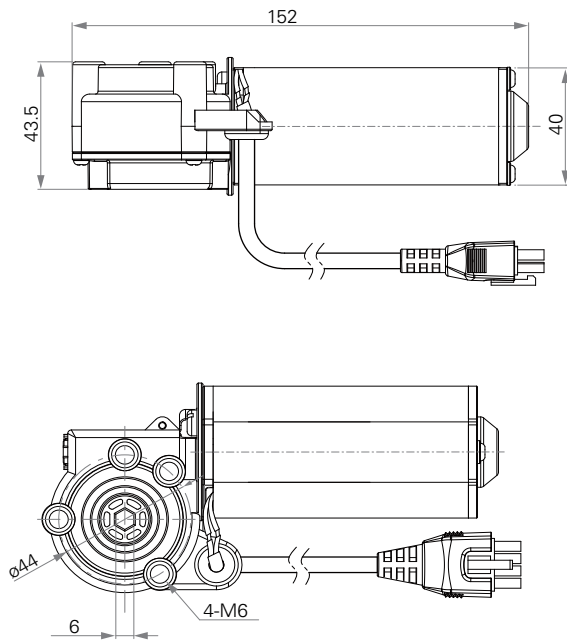

With TES2

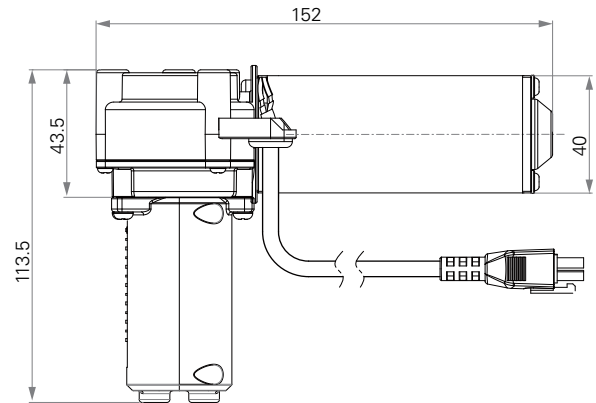

General Features

Voltage of motor	24V DC
Maximum speed	105RPM ($\pm 5\%$) after gear reduction
Maximum rated Torque	4.6Nm after gear reduction
Operational temperature range at full performance	+5°C~+45°C
Options	Hall sensor(s)
Hexagon hole for the shaft by 6mm diameter	
Low noise	

TGM3

Version: 20171130-H

Voltage	2 = 24V DC		
Load and Speed	See page 80		
Output Signal	0 = Without	1 = Hall sensor*1	2 = Hall sensors*2
Motor Brake	0 = Without		
Connector	0 = Tinned leads	1 = DIN 6P, 90° plug	2 = Molex 8P, plug
Cable Length (mm)	0 = Straight, 1000 1 = Straight, 1500	2 = Straight, 2000 3 = Curly, 1000	
Bracket	0 = Without		
External Limit Switches (TES2)	0 = Without	1 = With	
Output Rotation (If with TES2)	00 = Without	XX = Number of hexagon rotations (Between 13~17 turns & 25~35 turns.)	

TGM4

series



The TGM4 series is TiMOTION's compact size gear motor. It was designed primarily for ergonomic applications like height adjustable workstations and tables, but can be used in many other applications. This economical product allows for fast, smooth and quiet adjustment of built-in spindles through the use of external limit switches. Shafting allows for the mechanical synchronization of dual spindles.

Load and Speed

	CODE	Rated Torque (Nm)	Self Locking Force (Nm)		Typical Current (A)		Typical Speed (RPM±5%)	
			Brake #0	Brake #1	No Load 24V DC	With Load 24V DC	No Load 24V DC	With Load 24V DC
Motor Speed (3800RPM)	A	3.9	1.4	2.4	1.0	3.2	154.5	72
Motor Speed (2200RPM)	B	3.1	1.3	2.4	0.8	1.6	92.0	31
Motor Speed (5600RPM)	E	6.0	1.0	1.8	1.0	6.0	219.0	98

NOTE

1 Please refer to the approved drawing for the final authentic value.

Standard Dimension (mm)

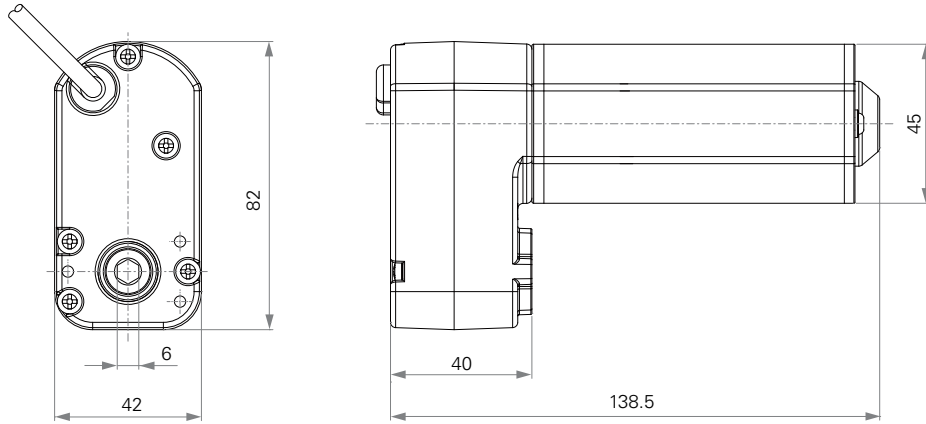

General Features

Voltage of motor	24V DC
Maximum speed at full load	98RPM ($\pm 5\%$) after gear reduction
Maximum rated torque	6Nm
Operational temperature range at full performance	+5°C~+45°C
Options	Hall sensor(s)
Hexagon hole for the shaft by 6mm diameter	
Low noise	

TGM4 Ordering Key

TGM4

Version: 20171220-I

Voltage	2 = 24V DC		
Load and Speed	See page 83		
Output Signal	0 = Without	1 = Hall sensor*1	2 = Hall sensors*2
Brake	0 = Without	1 = Motor brake	
Connector	0 = Tinned leads	1 = DIN 6P, 90° plug	2 = Molex8P, plug
Cable Length (mm)	0 = Straight, 1000 1 = Straight, 1500	2 = Straight, 2000 3 = Curly, 1000	
External Limit Switches (TES2)	00 = Without	XX = Number of output rotations (between 13~17 & 25~35 rotations, factory preset)	

TGM7

series



The TGM7 series is TiMOTION's compact size gear motor. It was designed primarily for ergonomic applications like height adjustable workstations and tables, but can be used in many other applications. This economical product allows for fast, smooth and quiet adjustment of built-in spindles through the use of external limit switches. Shafting allows for the mechanical synchronization of dual spindles.

Load and Speed

	CODE	Rated Torque (Nm)	Self Locking Force (Nm)		Typical Current (A)		Typical Speed (RPM±5%)	
			Brake #0	Brake #1	No Load 24V DC	With Load 24V DC	No Load 24V DC	With Load 24V DC
Motor Speed (5200RPM)	C	7.2	0.9	2.9	1.0	6.0	177	78
	D	3.6	0.2	0.7	1.0	6.0	355	156

NOTE

1 Please refer to the approved drawing for the final authentic value.

Standard Dimension (mm)

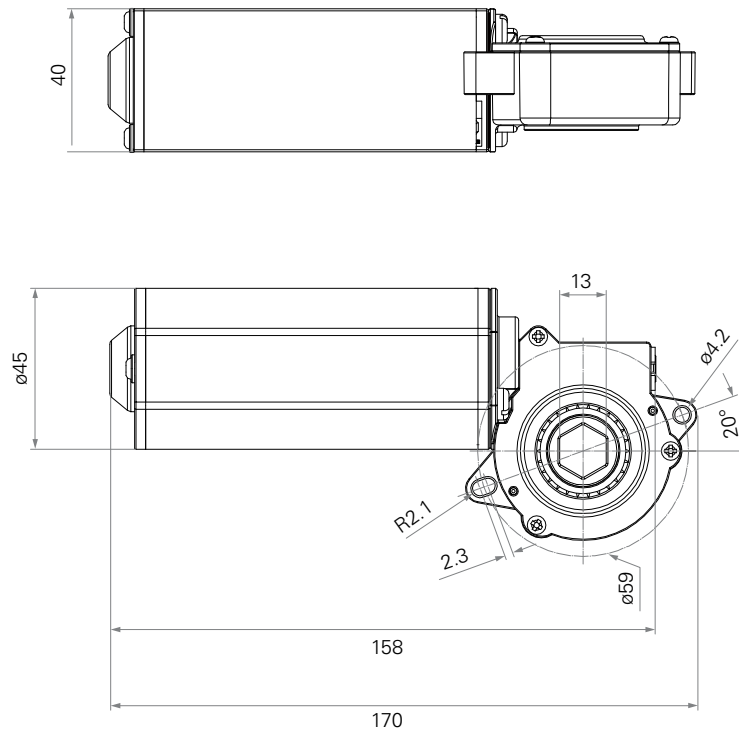

General Features

Voltage of motor	24V DC
Maximum speed at full load	156RPM ($\pm 5\%$) after gear reduction
Maximum rated torque	7.2Nm
Operational temperature range at full performance	+5°C~+45°C
Options	Hall sensor(s)
Low noise	

TGM7 Ordering Key

TGM7

Version: 20170520-C

Voltage	2 = 24V DC		
Load and Speed	See page 86		
Output Signal	0 = Without	1 = Hall sensor*1	2 = Hall sensors*2
Brake	0 = Without	1 = Motor brake	
Connector	0 = Tinned leads	1 = DIN 6P, 90° plug	2 = Molex 8P, plug
Cable Length (mm)	0 = Straight, 1000 1 = Straight, 1500	2 = Straight, 2000 3 = Curly, 1000	

TL3

series



The TL3 columns from TiMOTION are made up of three extruded aluminum tubes of rectangular shape that give the system great stability and a high stroke with reduced retracted length. This electric lifting column allows for an easy integration into many height adjustable applications.

Load and Speed

	CODE	Load (N)	Self Locking Force (N)	Typical Current (A)		Typical Speed (mm/s)	
				No Load 24V DC	With Load 24V DC	No Load 24V DC	With Load 24V DC
		Push					
Motor Speed (2200RPM)	B	4000	4000	2.5	6.3	14.5	7.6
	C	2000	2000	2.5	4.3	22.0	13.0
	D	1000	1000	2.5	3.8	39.0	24.0
Motor Speed (2800RPM)	E	4000	4000	3.5	7.5	18.5	9.4
	F	2000	2000	3.5	6.3	35.0	20.0
Motor Speed (3400RPM)	G	4000	4000	4.0	12.0	31.0	15.0

NOTE

- 1 With a 12V motor, the current is approximately twice the current measured in 24V; speed will be similar for both voltages.
- 2 Please refer to the approved drawing for the final authentic value.

Standard Dimension (mm)

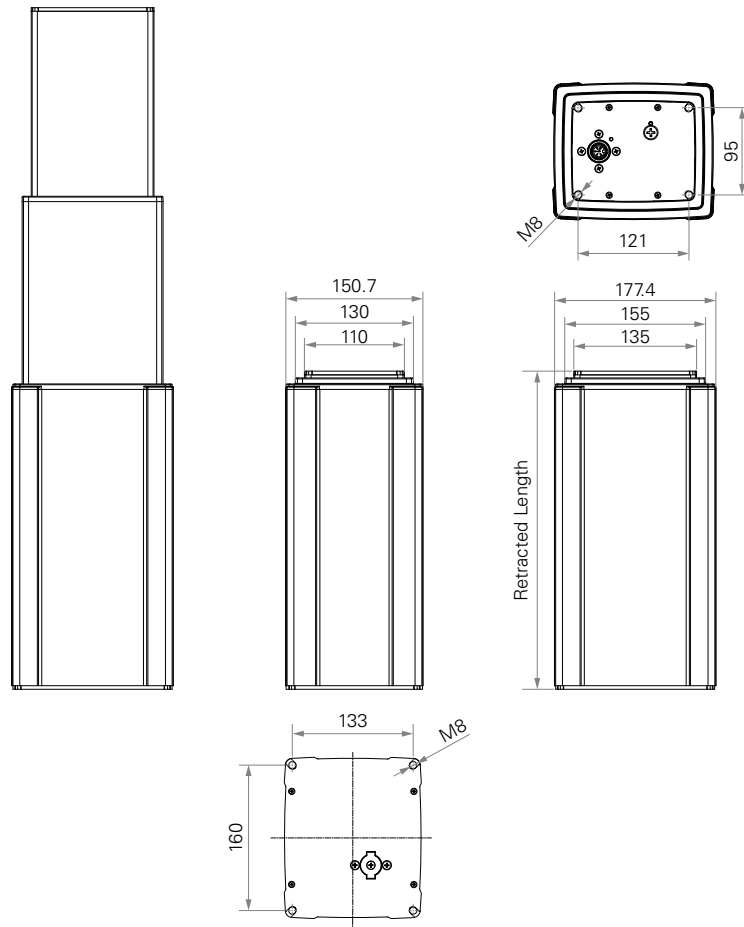

General Features

Maximum load	4,000N in push
Maximum dynamic bending moment	1,000Nm
Maximum static bending moment	2,000Nm
Maximum speed at full load	24mm/s (with 1,000N in a push condition)
Minimum installation dimension	Stroke/2+150mm
Dimension of cross section	177.4x150.7 mm
Stroke	250~1200mm
Operational temperature range	+5°C~+45°C
Options	POT, Hall sensor(s)

Performance Data

Motor Speed 24V DC 2200RPM, Duty Cycle 10%

Speed vs. Thrust

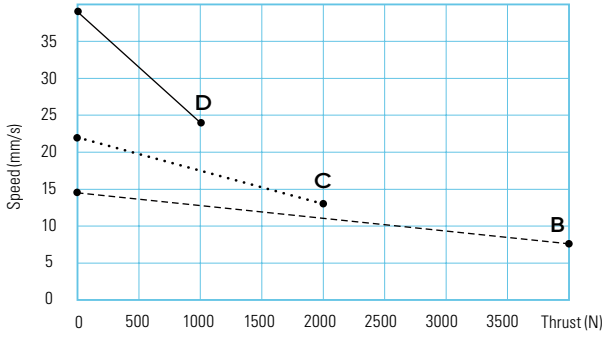

Current vs. Thrust

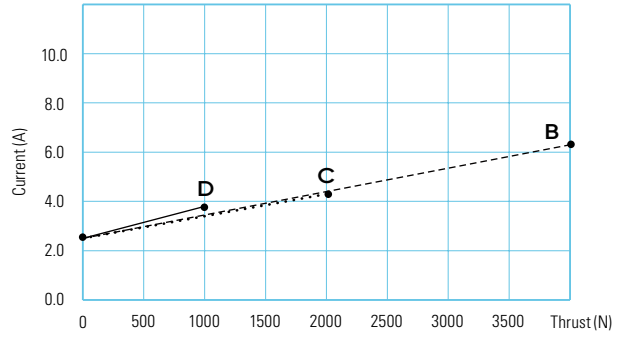

Motor Speed 24V DC 2800RPM, Duty Cycle 10%

Speed vs. Thrust

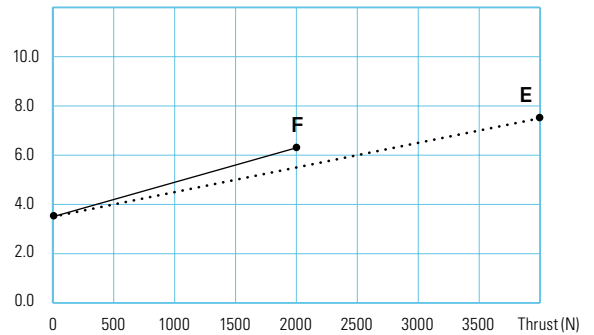
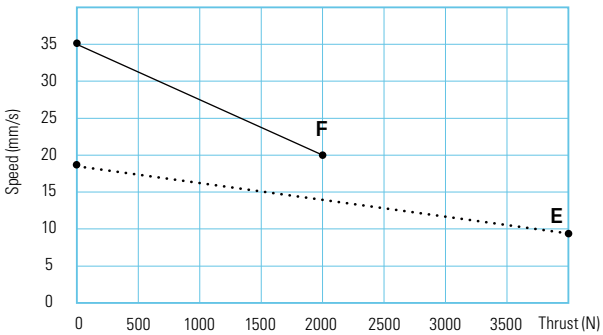

Motor Speed 24V DC 3400RPM, Duty Cycle 10%

Speed vs. Thrust

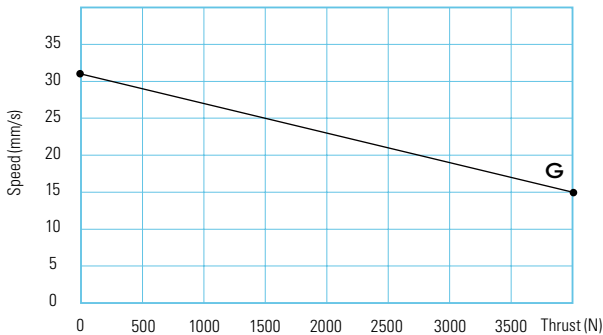

Current vs. Thrust

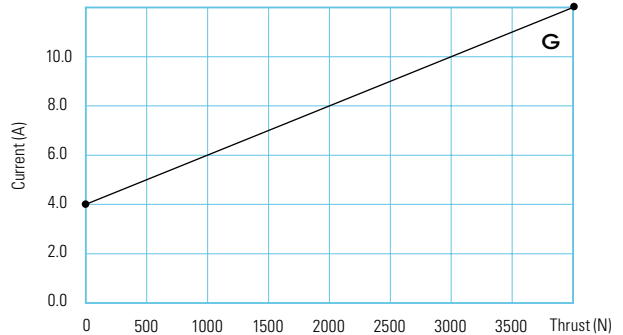

NOTE

1 The performance data in the curve charts shows theoretical value.

TL3 Top End Socket Ordering Key

TL3

Version: 20180423-N

Voltage	1 = 12V DC	5 = 24V DC, thermal protector	
Load and Speed	See page 89		
Stroke (mm)	250-1200		
Restracted Length (mm)	See page 90		
Cable Exit See page 95	1 = Top end socket		
Special Functions for Spindle Sub-Assembly	0 = Without (standard)	1 = Safety nut	
Functions for Limit Switches	1 = Two switches at full retracted / extended positions to cut current 3 = Two switches at full retracted / extended positions to send signal		
IP Rating	1 = Without	2 = IPX4	3 = IPX6
Output Signals	0 = Without	2 = Hall sensors*2	3 = POT
Connector See page 97	1 = DIN 6P, socket		
Cable Length (mm)	0 = Without (the corresponding extension cable TEC needs to be ordered seperately)		
Color	1 = Black	2 = Matte silver	
Tubes Direction See page 98	0 = Thinner on top	1 = Wider on top	
Grounding Function	0 = Without	1 = With	

NOTE

1 The TL18AC is designed especially for push applications, not suitable for pull applications.

TL3 Side Cable Ordering Key

TL3

Version: 20180423-N

Voltage	1 = 12V DC	5 = 24V DC, thermal protector	
Load and Speed	See page 89		
Stroke (mm)	250-1200		
Restracted Length (mm)	See page 90		
Cable Exit See page 95	2 = Bottom side cable	3 = Top side cable	
Special Functions for Spindle Sub-Assembly	0 = Without (standard)	1 = Safety nut	
Functions for Limit Switches	1 = Two switches at full retracted/ extended positions to cut current 3 = Two switches at full retracted/ extended positions to send signal		
IP Rating	1 = Without	2 = IPX4	3 = IPX6
Output Signals	0 = Without	2 = Hall sensors*2	3 = POT
Connector See page 97	1 = DIN 6P, 90° plug	2 = Tinned leads	F = DIN 6P, 180° socket
Cable Length (mm)	1 = Straight, 500 2 = Straight, 750 3 = Straight, 1000	4 = Straight, 1250 5 = Straight, 1500 6 = Straight, 1750	7 = Straight, 2000
Color	1 = Black (Black cable set) 2 = Silver (428C color cable set) 3 = Silver (Black cable set)		
Tubes Direction See page 98	0 = Thinner on top	1 = Wider on top	
Grounding Function	0 = Without	1 = With	

NOTE

1 The TL18AC is designed especially for push applications, not suitable for pull applications.

TL3 Direct Cut Ordering Key

TL3

Version: 20180423-N

Voltage	5 = 24V DC, thermal protector		
Load and Speed	See page 89		
Stroke (mm)	250-1200		
Restracted Length (mm)	See page 95		
Cable Exit See page 97	B = Top side- for TH; Bottom side- for TP C = Bottom side - Y cable, for TH + TP D = Top side - for the 2nd column; bottom side - for TH & TP; direct cut operation with 2 columns E = Top side - for the 2nd column & TH; bottom side - for TP; direct cut operation with 2 columns		
Special Functions for Spindle Sub-Assembly	0 = Without (standard)	1 = Safety nut	
Functions for Limit Switches	1 = Two switches at full retracted/extended positions to cut current		
IP Rating	1 = Without	2 = IPX4	3 = IPX6
Output Signals	0 = Without		
Connector See page 97	C = Direct cut, water proof, anti-pull		
Cable Length (mm)	B = Cable exit #B, L2=L3=100 C = Cable exit #C, L1=L2=L3=100	D = Cable exit #D, L2=L3=L4=100 E = Cable exit #E, L2=L3=L4=100	
Color	1 = Black (Black cable set) 2 = Silver (428C color cable set) 3 = Silver (Black cable set)		
Tubes Direction See page 98	0 = Thinner on top	1 = Wider on top	
Grounding Function	0 = Without	1 = With	

NOTE

1 The TL18AC is designed especially for push applications, not suitable for pull applications.

TL3

Ordering Key Appendix

Retracted Length (mm)

1. Minimum retracted length needs to $\geq A+B+C$

A. Retracted Length (mm)	Load (N)		
		1000	2000

Stroke/ 2+150 or Stroke/ 2+220*

*The minimum retracted length generated by the formula-Stroke/2+150 applies to the minimum bending moment rating. Please refer to the left column of the "Dynamic bending moment chart".

B. Cable Exit	Code	Top end socket	Bottom side cable	Side Cable	Direct Cut
	1, 2	-	-	-	-
	3	-	-	+15	-
	B, D, E	-	-	-	+35
	C	-	-	-	-

C. When with POT (When without POT, C=0)	Cable Exit	Top end socket	Bottom side cable	Top side cable
		1	2	3
		+40	+40	+40

Dynamic bending moment (Nm)- X direction	Stroke (mm)	Retracted Length (mm)	
		S/2+150	S/2+220
	100-300	700	1000
	301-500	500	800
	501-700	300	500
	701-1200	200	200

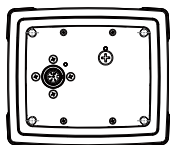

← Bending moment X

↑ Bending moment Y

NOTE

- 1 Bending moment Y direction= X*0.8
- 2 Static bending moment= dynamic*2

Functions for Limit Switches

Wire Definitions

	Pin	CODE	
		1	3
● Green	1	Extend (VDC+)	Extend (VDC+)
● Red	2	N/A	Common
○ White	3	N/A	Upper limit switch
● Black	4	N/A	N/A
● Yellow	5	Retract (VDC+)	Retract (VDC+)
● Blue	6	N/A	Lower limit switch

NOTE

1 See ordering key - functions for limit switches.

Cable Exit

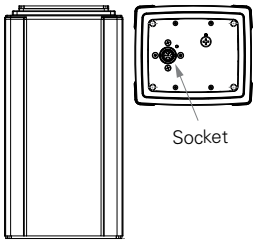

1 = Top end socket

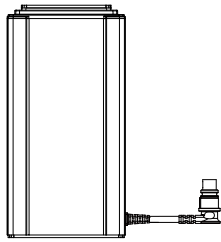

2 = Bottom side cable

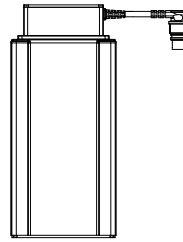

3 = Top side cable

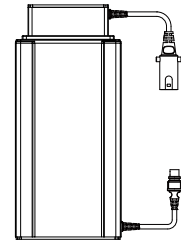

B = Top side- for TH; Bottom side- for TP

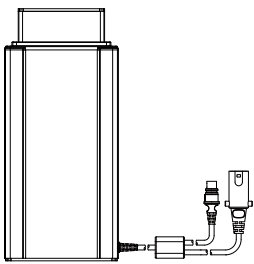

C = Bottom side- Y cable, for TH + TP

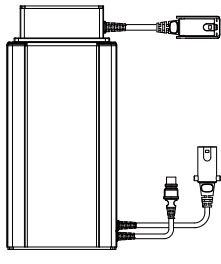

D = Top side- for the 2nd column; Bottom side- for TH & TP

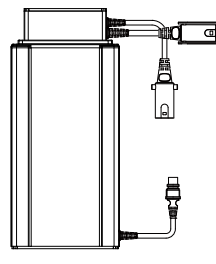

E = Top side- for the 2nd column & TH; Bottom side- for TP

Connector

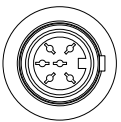

1 = DIN 6P, socket (Top end socket)

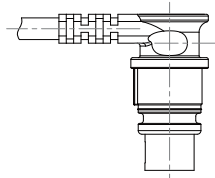

1 = DIN 6P, 90° plug

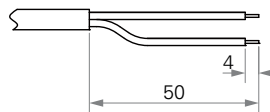

2 = Tinned leads

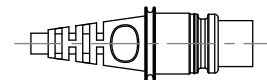

F = DIN 6P, 180° plug

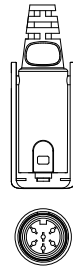
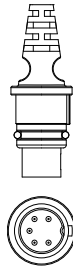
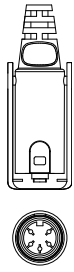

C = Directcut, water proof, anti-pull.
For TH: long DIN 5P (Pin array 240°), 180° socket (with anti-pull clip)

C = Directcut, water proof, anti-pull.
For TP: long DIN 5P (Pin array 240°), 180° plug (with O-ring)

C = Directcut, water proof, anti-pull.
For Column 2: long DIN 6P (Pin array 240°), 180° socket (with anti-pull clip)

Cable Length (mm)

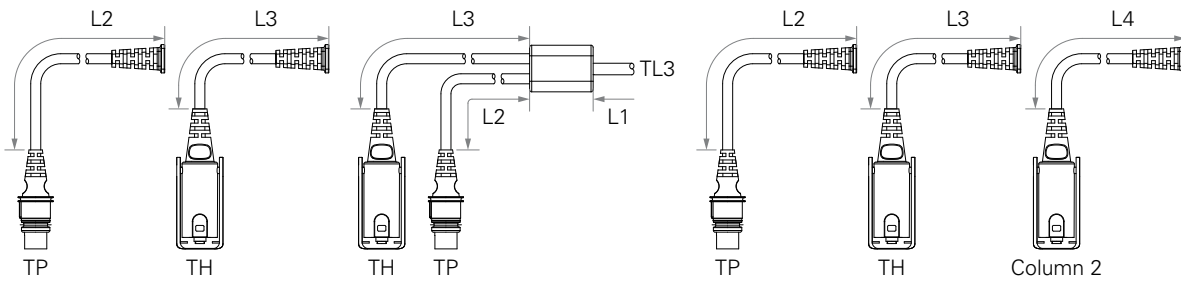

B = Cable exit #B, L2 = L3 = 100

C = Cable exit #C, L1 = L2 = L3 = 100

D, E = Cable exit #D, #E, L2 = L3 = L4 = 100

Tubes Direction

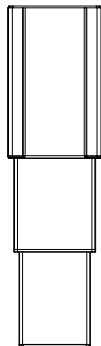
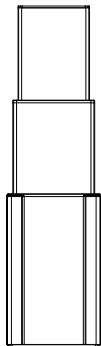

0 = Thinner on top

1 = Wider on top

TL18

series



TiMOTION's TL18 series electric lifting columns are designed for industrial applications like electric height adjustable workstations and screen or lifting tables. The TL18 features an extruded aluminum rectangular appearance. Our high capacity, yet economical, TL18 provides stable vertical lifting. This streamlines the engineering design process and replaces the older style, unsafe lifting mechanisms which have many moving stages and pinch points.

Load and Speed

	CODE	Load (N) Push	Bending Moment-X Direction (Nm)		Self Locking Force (N)	Typical Current (A)		Typical Speed (mm/s)	
			Dynamic	Static		No Load	With Load	No Load	With Load
						24V DC	24V DC	24V DC	24V DC
Motor Speed (3800RPM)	U	4500	250	500	4500	2.5	4.9	11.4	6.6
	Z	3000	250	500	3000	2.5	5.5	17.1	9.5
	W	2000	250	500	2000	2.5	4.8	22.9	13.1
	S	1500	250	500	1500	2.5	4.7	30.0	18.9
	V	500	250	500	500	2.5	4.0	45.0	28.0

NOTE

- 1 With a 12V motor, the current is approximately twice the current measured in 24V; speed will be similar for both voltages.
- 2 Self locking force: Tested average value when working with TiMOTION control system.
- 3 Y direction= X*0.8
- 3 Please refer to the approved drawing for the final authentic value.

Standard Dimension (mm)

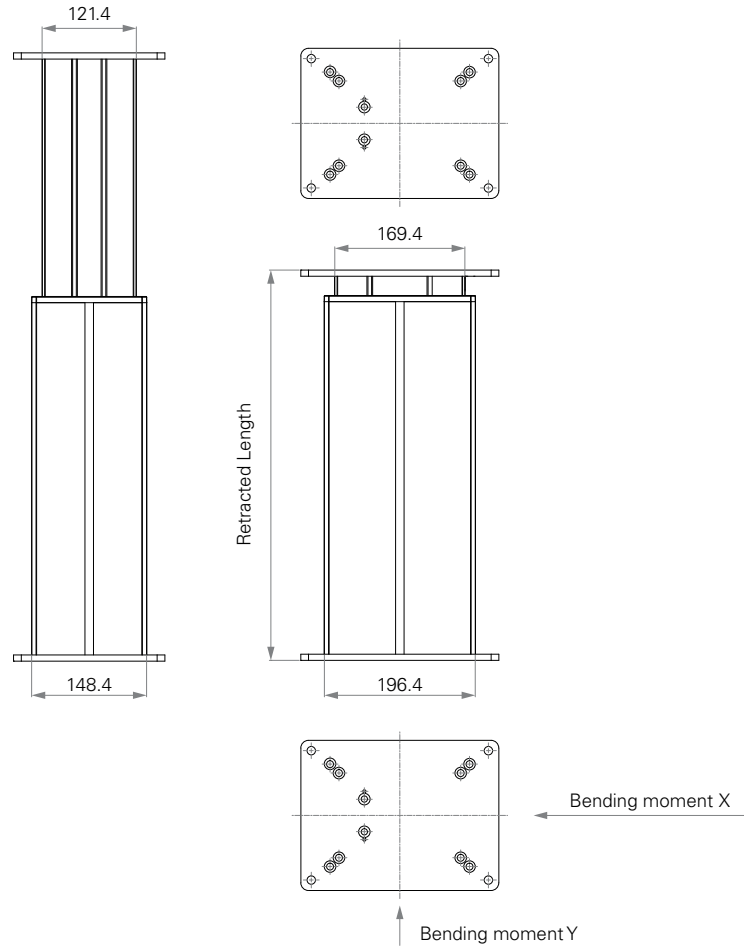

General Features

Maximum load	4,500N in push
Maximum dynamic bending moment	250Nm
Maximum static bending moment	500Nm
Maximum speed at full load	28mm/s (with 500N in a push condition)
Minimum installation dimension	Stroke + 147mm
Stroke	100~700mm
Operational temperature range	+5°C~+45°C
Options	Hall sensor(s), cable exit from top/bottom side, direct cut system

Performance Data

Motor Speed 24V DC 3800RPM

Speed vs. Thrust

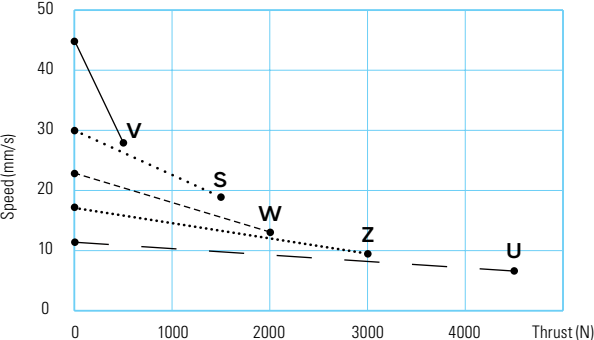

Current vs. Thrust

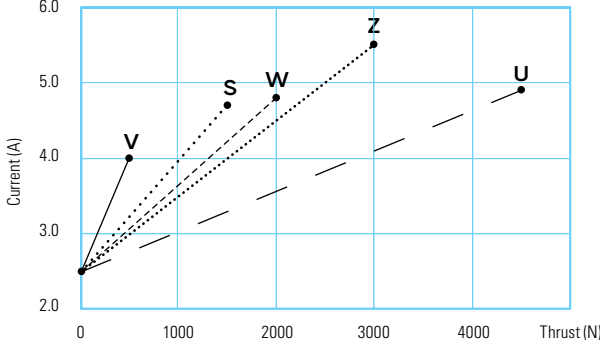

NOTE

1 The performance data in the curve charts shows theoretical value.

TL18 Ordering Key

TL18

Version: 20180328-G

Voltage	1 = 12V DC	2 = 24V DC	
Load and Speed	See page 99		
Stroke (mm)	100~700		
Restracted Lenth (mm)	See page 103		
Cable Exit See page 104	2 = Bottom side cable	3 = Top side cable	
Special Functions for Spindle Sub-Assembly	0 = Without (standard)	1 = Safty nut	
Functions for Limit Switches	1 = Two switches at full retracted / extended positions to cut current 3 = Two switches at full retracted / extended positions to send signal		
Color	1 = Black	2 = Matte silver	
IP Rating	1 = Without		
Output Signals	0 = Without	2 = Hall sensors*2	
Top Plate	1 = Small plate	2 = Big plate	
Bottom Plate	1 = Small plate	2 = Big plate	
Connector See page 104	1 = DIN 6P, 90° plug	C = Y cable, for direct cut system	E = Molex 8P, plug
Cable Length (mm)	1 = Straight, 500 2 = Straight, 750 3 = Straight, 1000	4 = Straight, 1250 5 = Straight, 1500 6 = Straight, 1750	7 = Straight, 200 B = For direct cut system, See page104

NOTE

1 The TL18 is designed especially for push applications, not suitable for pull applications.

TL18

Ordering Key Appendix

Retracted Length (mm)

1. Retracted length needs to \geq Stroke+A

A. Plate	Top Plate	Bottom Plate	
		1	2
	1	+147	+151
	2	+151	+155

Cable Exit

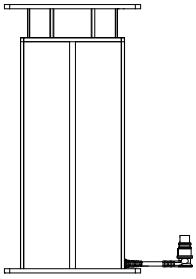

2 = Bottom side cable

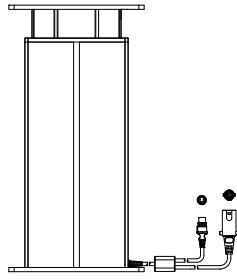

2 = Bottom side cable
Y cable, for TH + TP

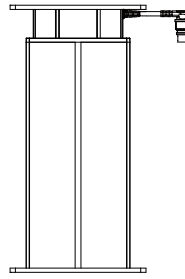

3 = Top side cable

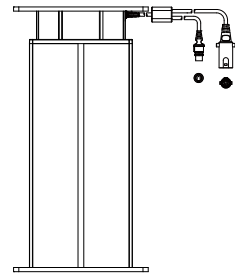

3 = Top side cable
Y cable, for TH + TP

Connector

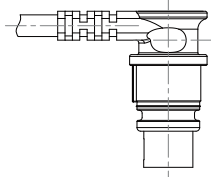

1 = DIN 6P, 90° plug

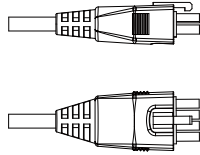

E = Molex 8P, plug

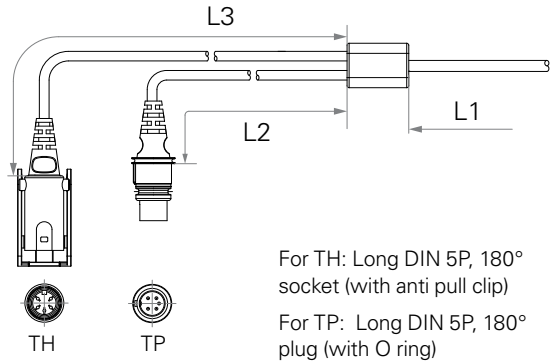

C = Y cable, for direct cut system

Cable length for direct cut system (mm)

Code	L1	L2	L3
B	100	100	100

TL18 AC series

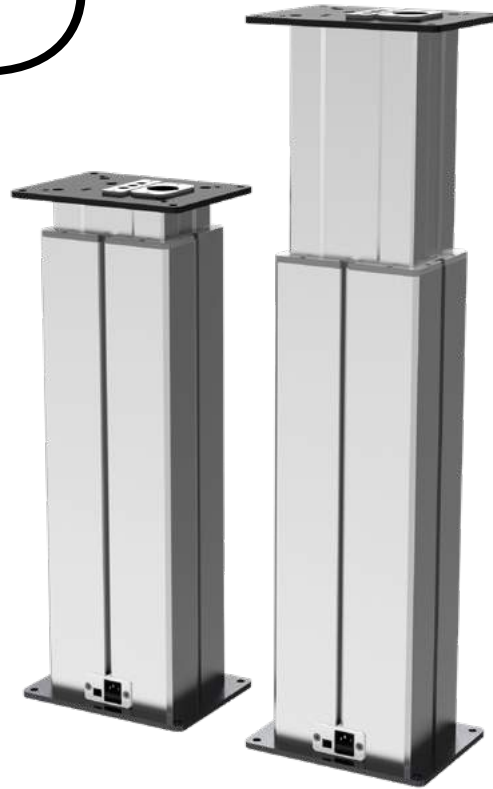

TiMOTION's TL18AC electric lifting column is designed for industrial applications such as height adjustable workstations, screen and lifting tables. The TL18AC features an extruded aluminum rectangular appearance. It is equipped with AC plug to connect the computers, TV or other device directly.

Load and Speed

	CODE	Load (N) Push	Bending Moment-X Direction (Nm)		Self Locking Force (N)	Typical Current (A)		Typical Speed (mm/s)	
			Dynamic	Static		No Load 24V DC	With Load 24V DC	No Load 24V DC	With Load 24V DC
Motor Speed (3800RPM)	U	4500	250	500	4500	2.5	4.9	11.4	6.6
	Z	3000	250	500	3000	2.5	5.5	17.1	9.5
	W	2000	250	500	2000	2.5	4.8	22.9	13.1
	S	1500	250	500	1500	2.5	4.7	30.0	18.9
	V	500	250	500	500	2.5	4.0	45.0	28.0

NOTE

- 1 Parameters above are from tested average, please refer to approval drawing for final value.
- 2 With a 12V motor, the current is approximately twice the current measured in 24V; speed will be similar for both voltages.
- 3 Y direction= X*0.8
- 3 Please refer to the approved drawing for the final authentic value.

Standard Dimension (mm)

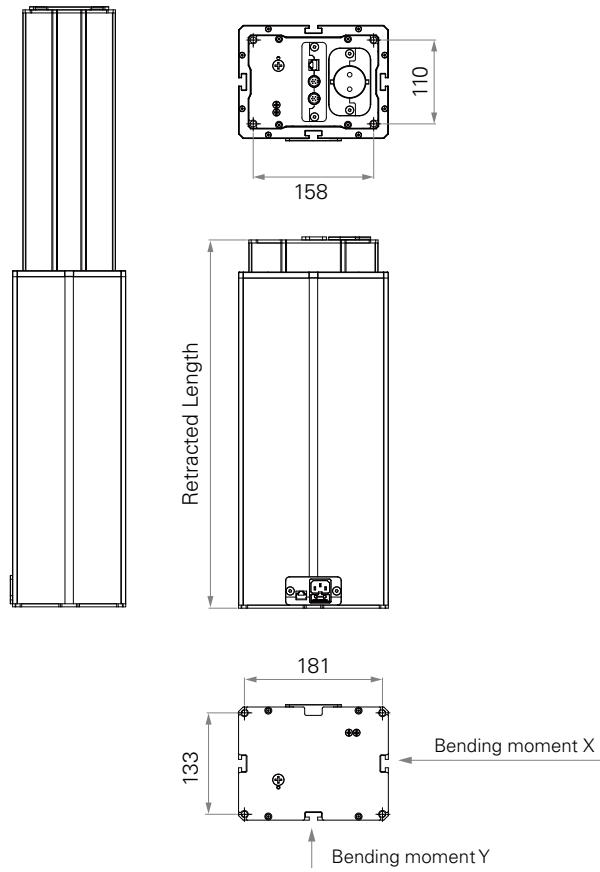

General Features

Maximum load	4,500N in push
Maximum dynamic bending moment	250Nm
Maximum static bending moment	500Nm
Maximum speed at full load	28mm/s (with 500N in a push condition)
Minimum installation dimension	Stroke + 183mm
Stroke	200~700mm
Operational temperature range	+5°C~+45°C
Options	AC cable exit from top end, top side; Ethernet socket

Performance Data

Motor Speed 3800RPM

Speed vs. Thrust

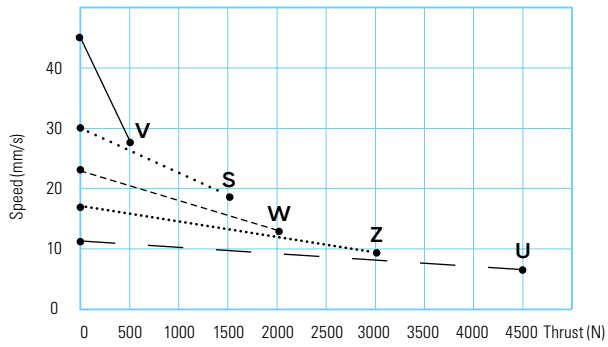

Current vs. Thrust

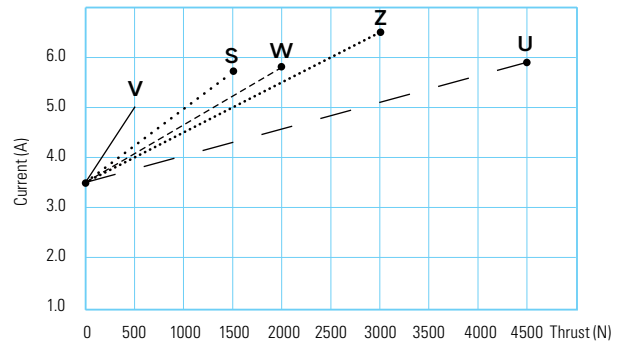

NOTE

1 The performance data in the curve charts shows theoretical value.

TL18AC Ordering Key

TL18AC

Version: 20180120-B

Voltage	U = 100-240VAC, SMPS		
Load and Speed	See page 105		
Stroke (mm)	200~700		
Restracted Lenght (mm)	See page 109		
Special Functions for Spindle Sub-Assembly	0 = Without (standard)	1 = Safety nut	
Color	1 = Black	2 = Matte silver	
Tubes & Sockets Position	See page 110		
Top Plate	1 = Small plate	2 = Big plate	
Bottom Plate	1 = Small plate	2 = Big plate	
AC Input Plug & Output Socket	5 = EU	6 = US	8 = UK
AC Cable Length (mm)	5 = Straight, 1500		
AC Output Socket	0 = Without	1 = With	
Direct Cut	K = 1 motor direct cut system		L = 1+1 motor direct cut system
Internet Socket	0 = Without	1 = With	

NOTE

1 The TL18AC is designed especially for push applications, not suitable for pull applications.

TL18AC

Ordering Key Appendix

Retracted Length (mm)

1. Calculate $A+B=Y$
2. Retracted length needs to \geq Stroke+Y

A. Top Plate

	Small	Big
	1	2
1	+8	+12
2	+12	+16

B. AC Output Socket

	Top End	Top Side
	1	3
0	+175	+209
1	+175	+229

Tube & Socket Position

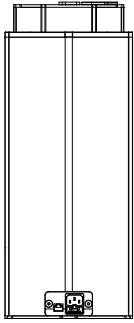

B = Tube: Thinner on top
Sockets: Top end

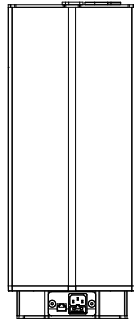

C = Tube: Thicker on top
Sockets: Top end

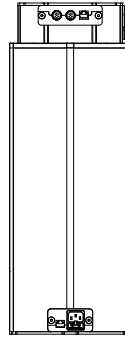

D = Tube: Thinner on top
Sockets: Top side



E = Tube: Thicker on top
Sockets: Top side

Direct Cut



K = 1 Motor direct cut. Control socket - Without motor socket.
Top end or top side - AC output & control socket

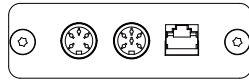

L = 1+1 motor direct cut. Control socket - With motor socket.
Top end or top side - AC output & control socket

Ethernet Socket



0 = Without Ethernet socket
Top end or top side- AC output & control socket

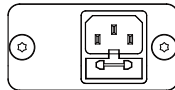

Bottom side - AC input



1 = With Ethernet socket
Top end or top side- AC output & control socket

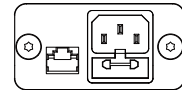

Bottom side - AC input

Top Plate Small

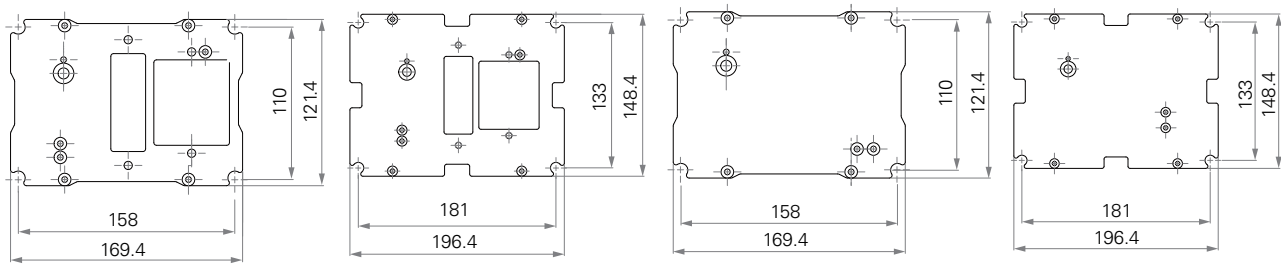

1 = Small plate - B

1 = Small plate - C

1 = Small plate - D

1 = Small plate - E

Top Plate Big

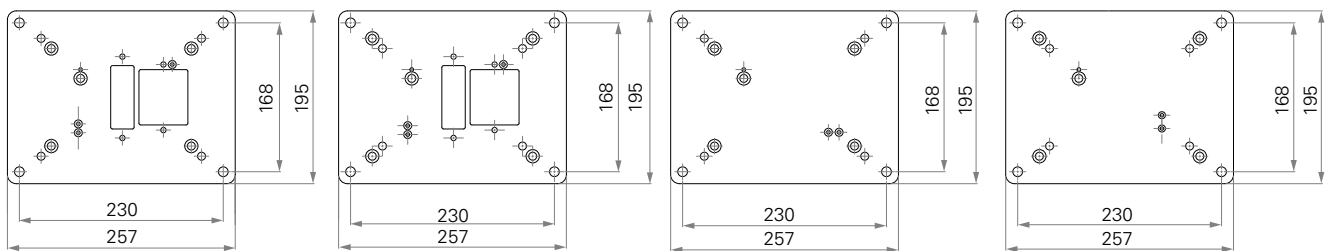

2 = Big plate - B

2 = Big plate - C

2 = Big plate - D

2 = Big plate - E

Bottom Plate Small

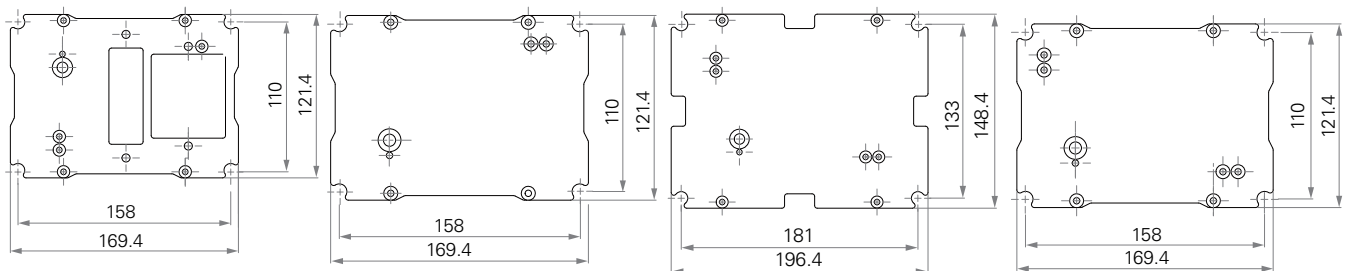

1 = Small plate - B

1 = Small plate - C

1 = Small plate - D

1 = Small plate - E

Bottom Plate Big

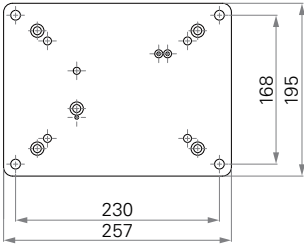

2 = Big plate - B

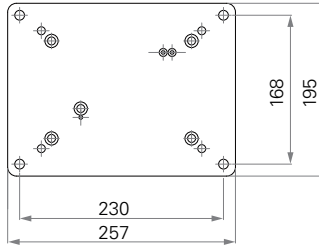

2 = Big plate - C

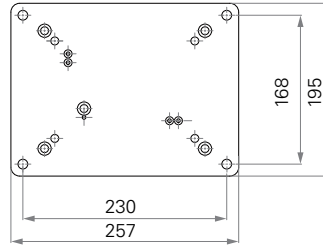

2 = Big plate - D

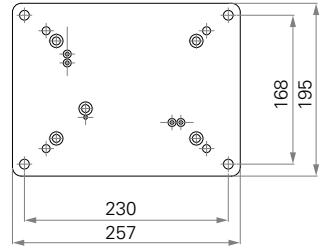

2 = Big plate - E

Terms of Use

The user is responsible for determining the suitability of TiMOTION products for a specific application. TiMOTION takes great care in providing accurate and up-to-date information on its products. However, due to continuous development, frequent modifications and changes to products may occur without prior notice. It is for this reason that TiMOTION cannot guarantee the correct and actual status of said information on its products, nor can it guarantee the availability of any particular product.

Therefore, TiMOTION reserves the right to discontinue the sale of any product displayed on its website or listed in its catalogues or other written material produced by TiMOTION.

For the most accurate and up-to-date information on our products, please refer to TiMOTION's website.

www.timotion.com



Every Day is Earth Day

TiMOTION uses FSC certified paper in order to help care for our forests, as well as the people and wildlife who call them home.

Contact Information

www.timotion.com
sales.tw@timotion.com

Headquarters

TIMOTION Technology Co., Ltd.

10F, No. 100 Minquan Rd,
Xindian Dist, New Taipei City,
23141, Taiwan
Tel 886 2 2219 6633
Fax 886 2 2219 0295

Corporate Offices

Dongguan

Shiyong Minying Industrial Zone,
Hengli Town, Dongguan City,
Guangdong, 523460, China
Tel 86 769 8706 2055
Fax 86 769 8706 2056

Kunshan

Room 14
(Building B, 2nd Floor, North),
Zhang Pu Zhen Qiu Road 88,
Kunshan City,
Jiangsu Province, China
Tel 86 512 5526 0735
Fax 86 512 5526 0736

Europe

1131 avenue Saint-Just,
77000 Vaux-le-Pénil, France
Tel 33 (0)1 74 82 50 51
Fax 33 (0)1 64 79 02 12
sales.eu@timotion.com

Sales office in Germany

Brandstr. 10,
53721 Siegburg, Germany
Tel 49 2241 1487902
Fax 49 2241 1487904
sales.eu@timotion.com

Korea

289 Sangsangok-dong,
Hanam-si, Gyeonggi-do, Korea
Tel 82 31 745 1060
Fax 82 31 794 1062
sales.kr@timotion.com

Japan

2-6-21, Kumata,
Higashisumiyoshi-ku,
Osaka, 546-0002, Japan
Tel 81 6 6713 1188
Fax 81 6 6713 1116
sales.jp@timotion.com

USA

1535 Center Park Drive,
Charlotte, NC 28217, USA
Toll free (855) 235 1424
sales.us@timotion.com

Latin America

Rua Pedro de Toledo, 80 - Vila
Clementino, São Paulo - SP,
04039-000, Brazil
Tel 55 (11) 5081 5011
sales.la@timotion.com

Distributors

TIMOTION is represented
in the following countries

- Australia
- Austria
- Brazil
- Czech Republic
- Finland
- India
- Italy
- Iran
- Netherlands
- Poland
- Spain
- Sweden
- Switzerland
- Turkey
- UK

