

JP4

series



Product Segments

- **Industrial Motion**

TiMOTION's JP4 series inline linear actuator is most similar to the JP3, but was designed for industrial applications that require higher load and speed. Its IP69K protection ensures it will withstand high temperature, high pressure water jets, and the ingress of dust and other solid contaminants. For synchronization and position feedback, the JP4 can be equipped with Hall sensors.

General Features

Voltage of motor	12/24V DC, or 12/24V DC (PTC)
Maximum load	4,500N in push
Maximum load	3,000N in pull
Maximum speed at full load	24mm/s (with 500N in a push or pull condition)
Stroke	≥ 20~1000mm
Minimum installation dimension	≥ Stroke + 289mm
IP rating	Up to IP69K
Color	Black or grey
Certificate	UL73
Operational temperature range	-5°C~+65°C
Operational temperature range at full performance	+5°C~+45°C
Storage temperature range	-40°C~+70°C
An inline actuator designed for small spaces	

Drawing

Standard Dimensions
(mm)

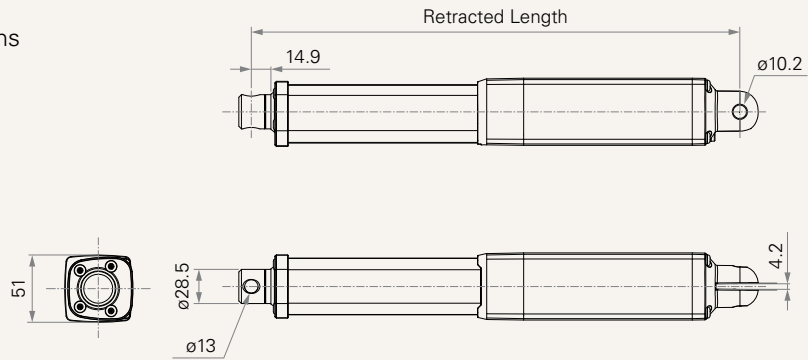

Load and Speed

CODE	Load (N)		Self Locking Force (N)	Typical Current (A)		Typical Speed (mm/s)	
	Push	Pull		No Load 24V DC	With Load 24V DC	No Load 24V DC	With Load 24V DC
Motor Speed (3800RPM, Duty Cycle 10%)							
B	4500	3000	4500	1.1	4.0	4.4	2.5
C	3500	3000	3000	1.1	4.0	6.5	4.0
D	2500	2500	2000	1.1	4.0	9.2	5.6
E	1500	1500	1000	1.1	3.0	12.0	9.5
F	1000	1000	700	1.1	3.0	18.0	14.0
G	500	500	500	1.1	3.0	27.5	24.0

Note

- 1 Please refer to the approved drawing for the final authentic value.
- 2 This self-locking force level is reached only when a short circuit is applied on the terminals of the motor. All the TiMOTION control boxes have this feature built-in.
- 3 The current & speed in table are tested with 24V DC motor. With a 12V DC motor, the current is approximately twice the current measured in 24V DC; speed will be similar for both voltages.
- 4 The current & speed in table are tested when the actuator is extending under push load.
- 5 The current & speed in table and diagram are tested with a stable 24V DC power supply.
- 6 Standard stroke: Min. ≥ 20 mm, Max. please refer to below table

CODE	Load (N)	Max Stroke (mm)
B	4500	400
C	3500	500
D	2500	600
E	1500	700
F	1000	800
G	500	1000

Performance Data (24V DC Motor)

Motor Speed (3800RPM, Duty Cycle 10%)

Speed vs. Load

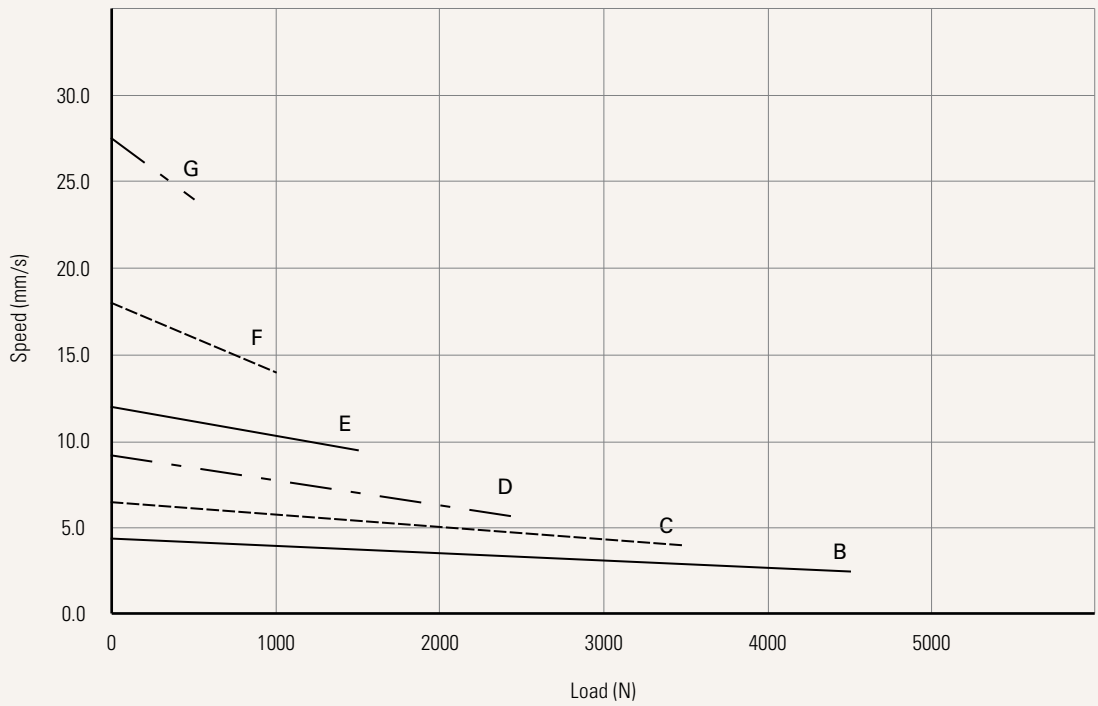

Current vs. Load

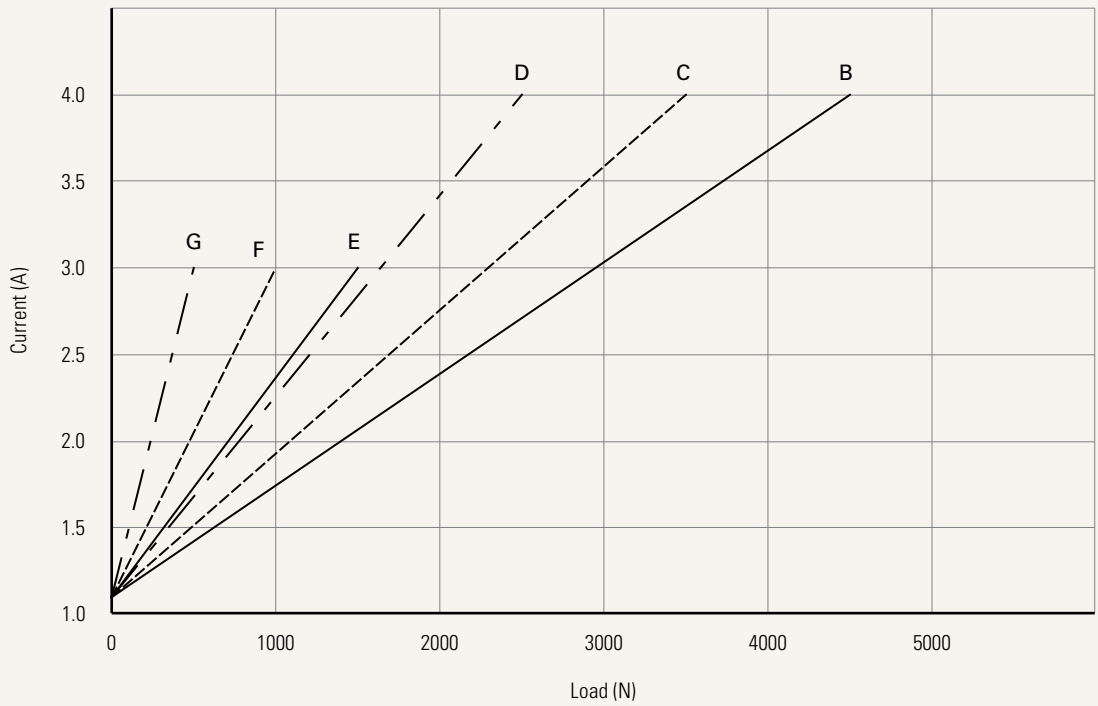

Voltage	1 = 12V DC	2 = 24V DC	5 = 24V DC, PTC	6 = 12V DC, PTC
See page 7				
Load and Speed	See page 2			
Stroke (mm)				
Retracted Length (mm)	See page 2			
Rear Attachment (mm)	1 = Aluminum casting, U clevis, slot 4.2, depth 18.0, hole 10.2			
See page 6				
Front Attachment (mm)	1 = Aluminum CNC, no slot, hole 13.0			
See page 6				
Direction of Rear Attachment (Counterclockwise)	1 = 0°			
See page 6				
Color	1 = Black	2 = Grey (Pantone 428C)		
IP Rating	1 = Without	3 = IP66	6 = IP66D	8 = IP69K
	2 = IP54	5 = IP66W	7 = IP68	
Special Functions for Spindle Sub-Assembly	0 = Without (Standard)			
Functions for Limit Switches	1 = Two switches at full retracted / extended positions to cut current			
See page 7	2 = Two switches at full retracted / extended positions to cut current + 3rd LS to send signal			
	3 = Two switches at full retracted / extended positions to send signal			
	4 = Two switches at full retracted / extended positions to send signal + 3rd LS to send signal			
Output Signal	0 = Without	2 = Hall sensors*2		
Connector	1 = DIN 6P, 90° plug	2 = Tinned leads		
See page 7				
Cable Length (mm)	0 = Straight, 100	1 = Straight, 500	3 = Straight, 1000	

Retracted Length (mm)

1. Calculate $A+B = Y$
2. Retracted length needs to \geq Stroke + Y

A. Rear Attachment

1	+289
---	------

B. Stroke (mm)

20~150	-
151~200	-
201~250	+10
251~300	+20
301~350	+30
351~400	+40
401~450	+50
451~500	+60
501~550	+70
551~600	+80
601~650	+90
651~700	+100
701~750	+110
751~800	+120
801~850	+130
851~900	+140
901~950	+150
951~1000	+160

Rear Attachment (mm)

1 = Aluminum casting, U clevis, slot
4.2, depth 18.0, hole 10.2

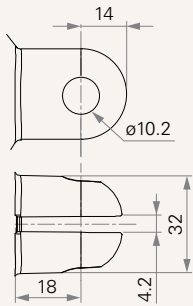

Front Attachment (mm)

1 = Aluminum CNC, no slot, hole 13.0

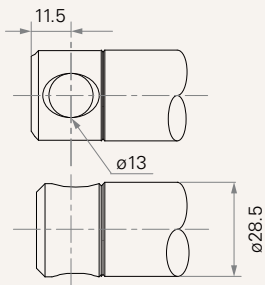

Direction of Rear Attachment (Counterclockwise)

1 = 0°

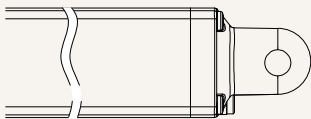

Functions for Limit Switches

Wire Definitions

CODE	Pin					
	● 1 (Green)	● 2 (Red)	○ 3 (White)	● 4 (Black)	● 5 (Yellow)	● 6 (Blue)
1	extend (VDC+)	N/A	N/A	N/A	retract (VDC+)	N/A
2	extend (VDC+)	N/A	middle switch pin B	middle switch pin A	retract (VDC+)	N/A
3	extend (VDC+)	common	upper limit switch	N/A	retract (VDC+)	lower limit switch
4	extend (VDC+)	common	upper limit switch	medium limit switch	retract (VDC+)	lower limit switch

Connector

1 = DIN 6P, 90° plug

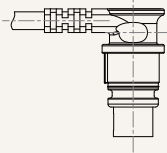

2 = Tinned leads

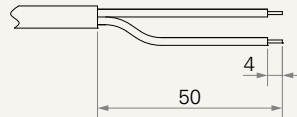

Voltage

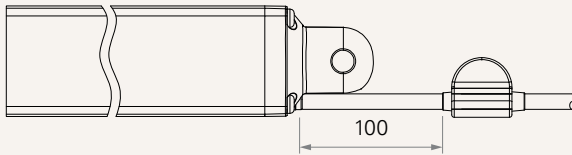

Terms of Use

The user is responsible for determining the suitability of TiMOTION products for a specific application. TiMOTION products are subject to change without prior notice.