

VERSION 4
USER MANUAL

ERGO KIT TC15 + Lift Columns

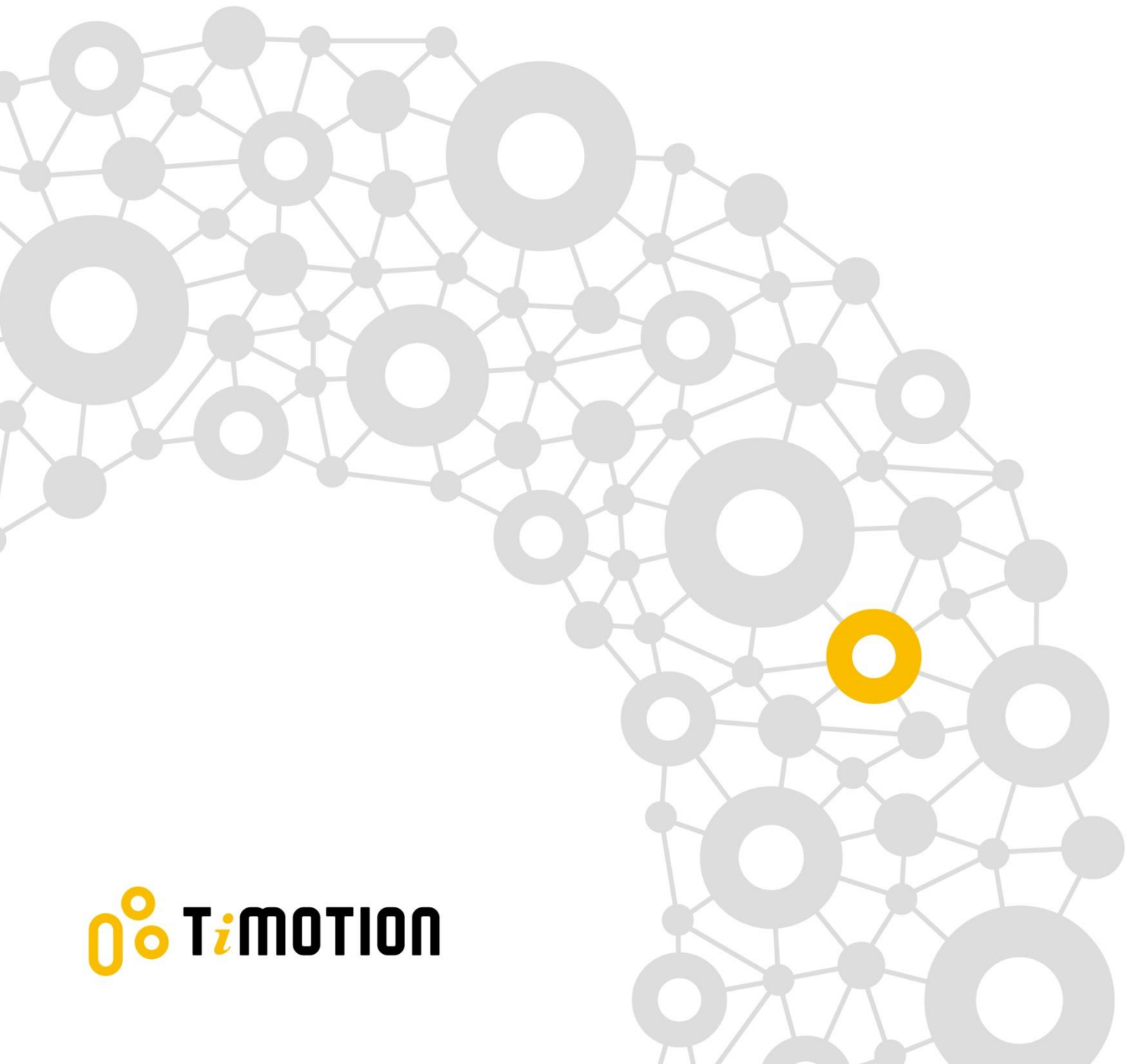

Contents

Contents	2
1. Preface	3
2. Applied Models	3
3. Important Information	7
4. Safety Instruction	7
4.1 Before Installation / Reinstallation	7
4.2 During Operation.....	8
4.3 Connection.....	8
5. Descriptions of the TiMOTION Ergo System	9
6. Mounting Guidance	10
7. Getting Started	13
7.1 Resetting	13
7.2 Operation.....	13
8. Anti-Collision	13
9. T-TOUCH Protection.....	14
10. Energy Preserving Feature.....	14
11. Disposal Guidance.....	14
12. Error Codes and Alerts.....	15
13. Troubleshooting	17
14. Labels	18
14.1 Control Box-TC15	18
14.2 Columns	19
15. TiMOTION Application Policy	20
16. History	21

1.Preface

We are delighted that you have chosen products from TIMOTION. Our ergonomic products are high-tech products based on many years of experience in the manufacturing and development of electric linear actuators, electronic control boxes, hand controls, and power supplies. We are constantly improving our products to meet and exceed customer expectations.

This User Guide will advise you about how to install, use and maintain your Ergo Motion products. We are sure these products will provide you with many years of reliable operation. All TiMOTION products undergo rigorous functionality and quality testing prior to shipping. You are always welcome to contact our local corporate offices or sales agents for any questions you may have. It is our goal and pleasure to assist you.





2.Applied Models

This user manual will discuss the following products:



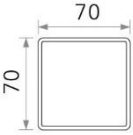
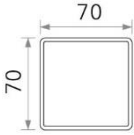

Control Box

Model	TC15
Motor Support	Two
Dimension (mm)	242(L) x 94(W) x 40(H)
Column support	2 stage
	3 stage
	3 stage (M)
	3 stage (S)
Photo	



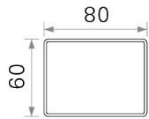
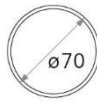
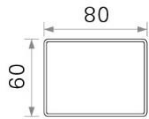



Lifting Columns 1:

Model	TL4	TL7	TL9
# of telescopic stages	3	3	3
Shape	Square	Square	Round
Features	Narrow top/Wide bottom	Wide top/Narrow bottom	Narrow top/Wide bottom
Size	70 x 70	70 x 70	ø70
Profile (mm)			
sMax. rated load (kg)	80	80	80
Max. speed at full load (mm/s)	33	33	33
Stroke (mm)	650 660 (M) 660 (S)	650 660 (M)	650 660 (M)
Min. dimension (mm)	590 560 (M) 520 (S)	590 560 (M)	590 560 (M)
Photo			

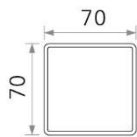
Lifting Columns 2:

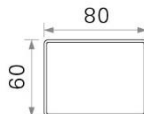
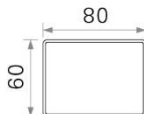
Model	TL10	TL11	TL12
# of telescopic stages	3	3	3
Shape	Rectangular	Round	Rectangular
Features	Narrow top/Wide bottom	Wide top/Narrow bottom	Wide top/Narrow bottom
Size	80 x 60	ø70	80 x 60
Profile (mm)			
Max. rated load (kg)	80	80	80
Max. speed at full load (mm/s)	33	33	33
Stroke (mm)	650 660 (M)	650 660 (M)	650 660 (M)
Min. dimension (mm)	590 560 (M) 520 (S)	590 560 (M)	590 560 (M)
Photo			

Lifting Columns 3:

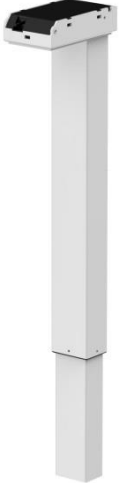
Model	TL13	TL14	TL15	TL26
# of telescopic stages	2	2	2	2
Shape	Square	Round	Rectangular	Rectangular
Features	Narrow top/Wide bottom	Narrow top/Wide bottom	Narrow top/Wide bottom	Wide top/Narrow bottom
Size	70 x 70	ø70	80 x 60	80 x 60
Profile (mm)				
Max. rated load (kg)	80	80	80	80
Max. speed at full load (mm/s)	28	28	28	28
Stroke (mm)	500	500	500	500
Min. dimension (mm)	645	645	645	645
Photo				

Controls:

All Ergo Motion product line controls

3. Important Information

- (1) Irrespective of the load the Duty cycle is 10%, max. 2 minutes operating / min. 18 minutes stop.
- (2) Maximum load of each column is 80kg, 120Kg for 2 columns equally divided. Ensure the loading does not exceed the rating, otherwise it might cause permanent damage to the column(s) during operation.
- (3) When the motor cable is connected to the control box, each column can maintain an adequate locking force up to 80kg load (120kg for 2 columns). However, when the cable is damaged or is disconnected from the control box, it will cause the column to gradually slide to the bottom, if the load on either column is greater than 60kg.
- (4) Damaged cords must be replaced before connecting the power cable.
- (5) Do not operate the products if the ambient temperature is outside of the specified limits.
- (6) Do not lift the columns before the assembly is completed.

4. Safety Instruction

4.1 Before Installation / Reinstallation

- (1) Make sure that the appliance is being installed as described under the Connection section, page 8, within this user guide. When installing and using electrical equipment, basic safety precautions should always be followed to avoid a risk of fire, electric shock, or injury to persons.
- (2) If the power cord is damaged, it must be replaced by the manufacturer, its service agent or a similar qualified person in order to avoid hazard.
- (3) Not to be opened by unauthorized personnel (control box, motor housing, hand control)
- (4) **RISK OF ELECTRIC SHOCK.** Insert the plug only into proper socket only. If it does not fit, contact a qualified electrician to install the proper outlet. Do not change the plug in any way.
- (5) The control box is only used for the specified linear actuators, do not use appliances not recommended by the manufacturer.
- (6) Never drop or insert any object into any opening.
- (7) Make sure the correct tools and assembly parts are used when mounting the system.
- (8) Be aware that the control box can only be connected to the voltage printed on the label.
- (9) Before moving the columns, remove the plug from main power supply.

4.2 During Operation

- (1) Not intended for use by children.
- (2) For indoor use only.
- (3) Do not use the system when the load exceeds the rating.
- (4) Unplug from outlet before installing or removing parts.
- (5) Take care that the cables are not damaged.
- (6) Keep the cord away from heated surfaces.
- (7) Do not operate where aerosol (spray) products are being used or where oxygen is being administered.
- (8) To properly disconnect the system, lower columns to minimum height, then remove plug from outlet.
- (9) If the control box or the columns make any unusual noises or smells, immediately unplug table from power supply.
- (10) Any servicing is to be performed by an authorized service representative.

4.3 Connection

Before the control box is connected to the main power supply, the individual parts of this system must be connected as described below:

Step 1.

Column(s) must be connected with control box using supplied cables.

Step 2.

Hand control must be connected with control box.

Step 3.

Control box must be connected to power supply.

5. Descriptions of the TiMOTION Ergo System

- ◆ **Column Movement**

The listed TL models are equipped with hall sensor motors. Through this feedback, the control box software can adjust the speed of column movement to ensure the columns remain synchronized during operation. The signal feedback also allows the software to determine the position of columns, which defines the travel range of the columns and makes the memory position setting and soft start/stop possible.

- ◆ **Duty Cycle**

The duty cycle of the system is 10% - Max 2 min. run / 18 min. stop at continuous use at full load. Exceeding the duty cycle will result in motor overheating and degradation of components, which will cause a dramatic reduction of the life of the system. Unless otherwise modified by customer, overuse protection to restrict the operating time is also part of software.

- ◆ **Class II**

A Class II or double insulated electrical appliance is one which has been designed in such a way that it does not require a safety connection to electrical earth (US: ground).

The basic requirement is that no single failure can result in dangerous voltage becoming exposed so that it might cause an electric shock. This is achieved without relying on an earthed metal casing. This is usually achieved at least in part by having two layers of insulating material surrounding live parts or by using reinforced insulation.



6. Mounting Guidance

◆ Control Box-TC15

The TC15 is fastened with two screws consisting of a head diameter between $\varnothing 4$ and $\varnothing 5$ mm. See the drawing appendix for placement of the mounting holes and TC15 dimensions.

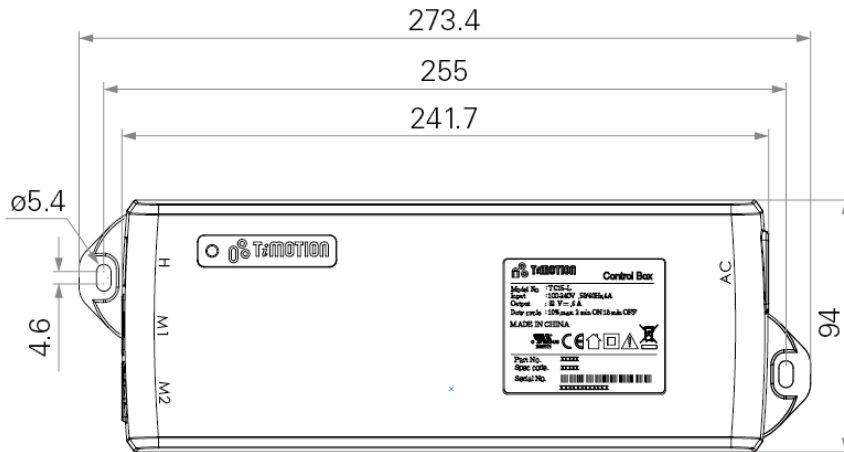

◆ Columns

All TiMOTION ERGO columns, which include a motor housing, share the same motor housing design.

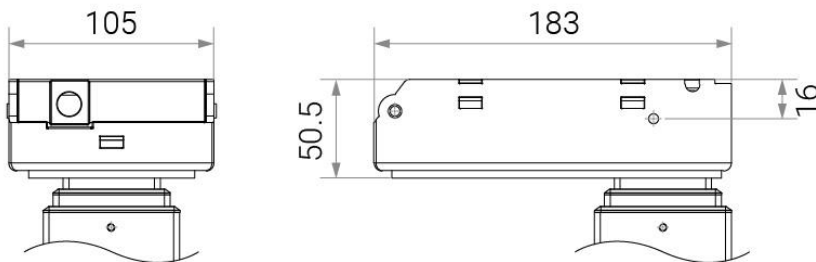

Flared Lip

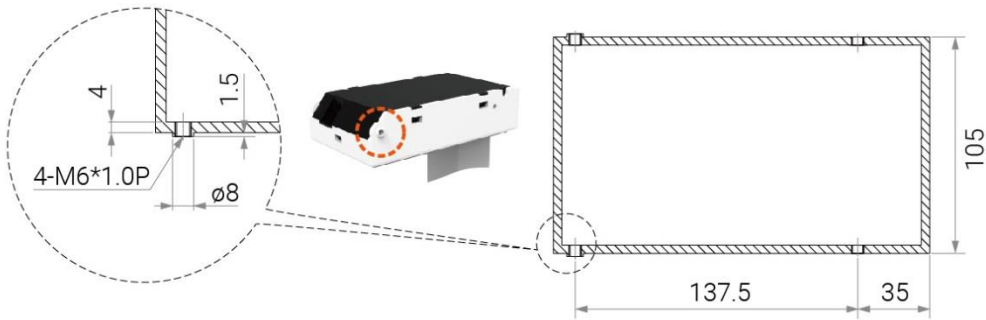

Flush Hole

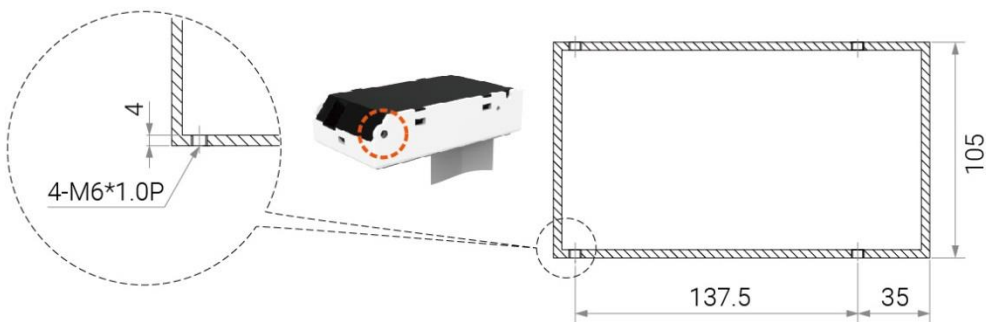

Suggested thread length for foot bolts (mm): T (foot thickness) + 8 + 0~2 (tolerance)

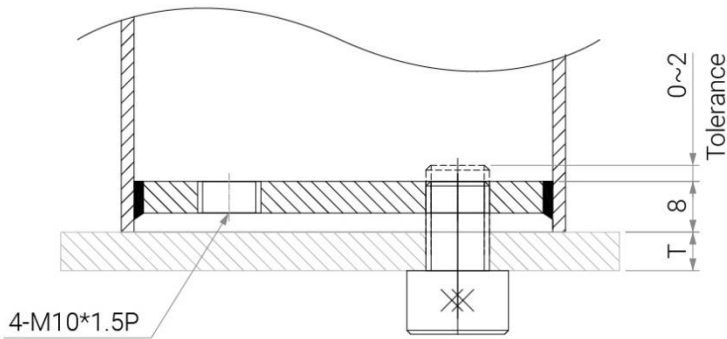

Suggested thread length of the motor housing bolts (mm): T (frame thickness) + 4 + 0~8 (tolerance)

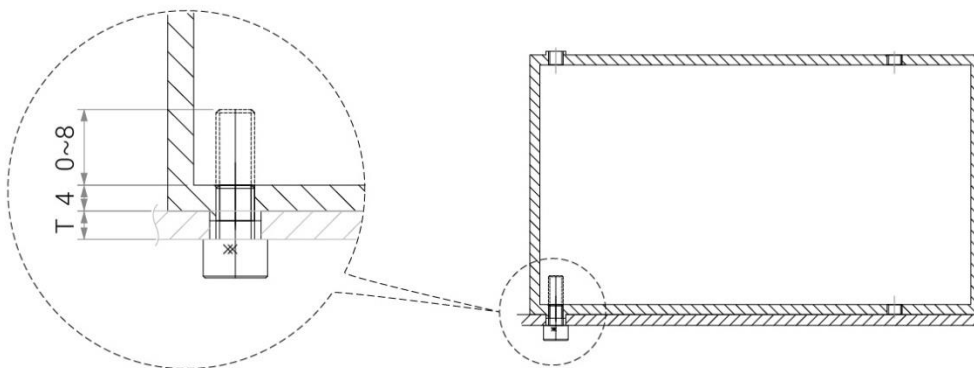

- ◆ **Electrical Connection**

The system wiring should be connected as shown in the diagram below. Each column will be connected to the sockets on the control box via the motor cables, which have an eight-pin plug on one side (next to the control plug).



7. Getting Started

7.1 Resetting

- (1) Press and hold the ▲ and ▼ buttons on the hand control at the same time for 3 seconds.
- (2) Continue holding the buttons until both legs reach the lowest position.
- (3) Once the reset procedure has been completed, the hand control will beep once and the buttons can be released.

7.2 Operation

- (1) Press and hold the ▲ button to raise the desk.
- (2) Press and hold the ▼ button to lower the desk.

Note: For controls with memory functionality, please contact TiMOTION for the respective user guides.

8. Anti-Collision

The control boxes for TiMOTION's Ergo Motion products are programmed with an anti-collision function which may reduce damage to the columns in the event of collision with a firm object. When the column is raised / lowered, the power consumption of each column is monitored and compared to a software algorithm.

If the power consumption for the columns is increased relative to a predetermined value, the system assumes there is an obstruction (collision). Once an obstruction is detected, the columns will stop and then move in the opposite direction. This opposite movement is automatic and continues for 40 mm without activating the hand control.

The sensitivity of this anti-collision is different during upward or downward motion. The anti-collision activates with a force of approximately +25 kg upwards and downwards the anti-collision activates with a force of approximately + 35 kg + weight on the column(s).

9. T-TOUCH Protection

(Optional accessory- TCS1)

T-Touch is a new hardware based solution that can detect if a system has collided with an object, become uneven or shifted during operation. If one of these conditions is met, T-Touch immediately sends the control box a command to stop and reverse the desk from raising or lowering. Compared to TiMOTION's current software-based detection system, T-Touch is more sensitive, stable and works independently of load and temperature.

TCS1 is a collision sensor based on T-Touch technology which can be integrated easily into the control system and does not require any additional hardware upgrades. When paired with the TiMOTION control system, TCS1 allows for three axis collision detection. This sensor provides enhanced safety to your electric height adjustable desk or system to help prevent user injury or equipment damage.

10. Energy Preserving Feature

(Optional)

When the table is left in position for more than 30 seconds, it will go into standby mode in order to reduce unneeded energy consumption. When adjusting your table after a dormant period, hold the up or down button to disable standby mode.

11. Disposal Guidance

TiMOTION's Ergo series product may be disposed by dividing components into different waste groups for recycling or combustion. We recommend the Ergo series is disassembled as much as possible before disposal. The main groups to sort for waste are: Metal, plastic, cable scrap, combustible material and collection for recoverable resources.

Some of these main groups can be sub-divided into groups e.g. metal can be divided into steel and aluminum or plastic can be divided into ABS and PP. All plastic parts > 50g are provided with an internal code for plastic types.

The example below shows the recycling groups in which the different components of the TEK series should be placed into:

Products	Components	Recycling group
Columns	Spindle and motor Plastic housing Cable PCB boards	Scrap Plastic recycling or combustion Cable scrap or combustion Electronics scrap
Control box	Spindle and motor Plastic housing Cable Transformer	Electronics scrap Plastic recycling or combustion Cable scrap or combustion Metal scrap
Controls	Plastic housing Cable PCB boards	Plastic recycling or combustion Cable scrap or combustion Electronics scrap

12. Error Codes and Alerts

Note: This function requires bigger MCU #5628

Error Code	Protection	Situation	Buzzer Alert	Solution
000	Resetting	Press both buttons at the same time for 3 seconds. Continue pressing the buttons until both columns are in lowest position.	1 Beep	
E00	Not fully reset	When reset is required but not fully reset	No Beep	Can be operated after resetting
E01	Overuse protection	Continuous running the frame for 300 sec. will activate the overheat protection.	3 beeps 3 beeps when operating before completely recovering	The system will recover and after 75 sec. it is possible to run the frame for 300 seconds again. If the resting time or the interval between operations is too short, the next running time will be reduced in order to give the system enough time to cool

				down.
E02	Imbalance protection	Difference between 2 motors >10mm	2 beeps	Can be operated after resetting
E03	Anti-collision	Detecting the variation of electric current , motor will stop when excessive variation detected in a certain time.	No Beep. Reverses 40mm completely no matter keeping press the button or not.	Can be operated after reversing
E04	T-Touch Protection	Detecting if the system has collided with an object, become uneven or has shifted during operation	No Beep. Reverses 40mm completely no matter keeping press the button or not.	Can be operated after reversing / Remove the obstacle
E11	M1 Motor over-current protection	When one of the columns is overloaded or internal transmission is jammed)	5 beeps	Remove some load from your desk to lower the current to operate the system. If the system is not operational, nut might be broken or spindle / bracket might be damaged.
E12	M2 Motor over-current protection	When one of the columns is overloaded or internal transmission is jammed)	5 beeps	
E21	No hall sensor from M1	Only current is detected, no hall sensor. Column is not moving	Beep for 2 seconds, the screen flashes E21 for 5 seconds	Change motor or motor cable. Reset before operating
E22	No hall sensor from M2	Only current is detected, no hall sensor. Column is not moving	Beep for 2 seconds, the screen flashes E22 for 5 seconds.	Change motor or motor cable. Reset before operating
E31	No current from M1	No current is detected from M1, Column is not moving (Another column slightly shakes)	4 beeps; the screen flashes E31 for 5 seconds	Check if the motor plug is connected well

E32	No current from M2	No current is detected from M2, Column is not moving (Another column slightly shakes)	4 beeps; the screen flashes E32 for 5 seconds	Check if the motor plug is connected well
-----	--------------------	---	---	---

13. Troubleshooting

Problems	Observance	Solutions
The column(s) will not move.	<ul style="list-style-type: none"> ◆ Is the power cable connected to the main power supply with correct voltage? ◆ Make sure that all plugs are mounted correctly in the control box and to the column(s). ◆ One or more columns/cables are defective. ◆ Look for visible damages on cables, control box and columns. 	<ul style="list-style-type: none"> ◆ Connect plug to main power supply to make sure the voltage is ok. ◆ Check all connections. ◆ Perform reset and move columns(s) upwards. If the column(s) will not move upwards after reset is performed, it is defective. ◆ Damaged parts must be exchanged – contact TiMOTION.
The column(s) operates irregularly or 2 (or more) columns are unbalanced.	<ul style="list-style-type: none"> ◆ Visual observation. 	<ul style="list-style-type: none"> ◆ Perform reset.
The column(s) stops and can only move downwards.	<ul style="list-style-type: none"> ◆ Is the column in the highest position? ◆ The column could be overloaded. 	<ul style="list-style-type: none"> ◆ When the column has reached the maximum height, it will only move downwards. ◆ Remove some of the load and perform again.
The column(s) will only move downwards even though column(s) is not overloaded.	<ul style="list-style-type: none"> ◆ Visual observation. 	<ul style="list-style-type: none"> ◆ Perform reset.
The column(s) always stops at	<ul style="list-style-type: none"> ◆ Has the system been 	<ul style="list-style-type: none"> ◆ Perform reset.

<p>the same position, before reaching maximum height.</p>	<p>programmed to this specific height?</p>	
<p>Not all columns move when adjusting downwards.</p>	<ul style="list-style-type: none"> The column that does not move could be defective or the cable connection for the column could be defective. 	<ul style="list-style-type: none"> Check all connections, and then perform reset. If the column will not move after reset it is defective. Damaged parts must be exchanged – contact TiMOTION.

14. Labels

14.1 Control Box-TC15

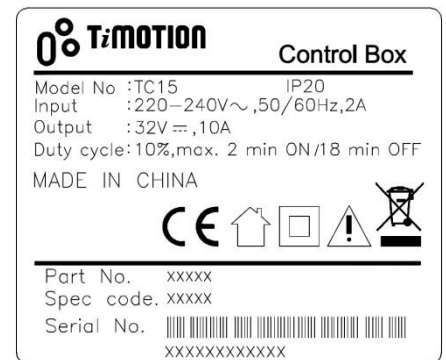
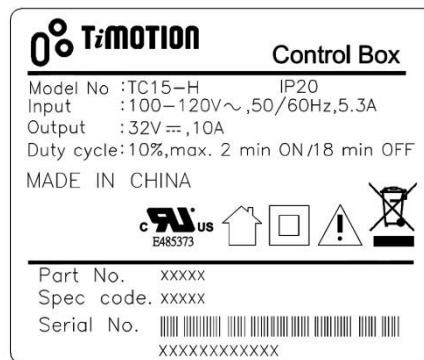
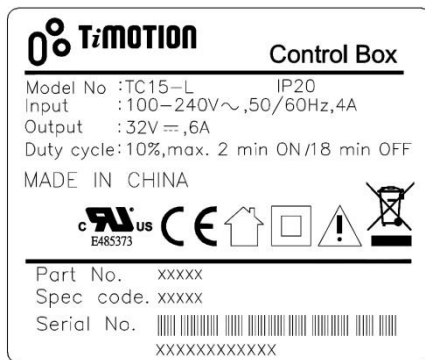





14.2 Columns

TL4

T:MOTION

Model No. : TL4
 Power Rating : DC24V
 Duty cycle : 10% Max 2Min ON/18Min OFF
 Max.Load : Push 800N
 Max.Current : Max.6.0Amp





Part No. 
 TL4-2C-650590-102E4

Serial No. 
 201010110001

TL7

T:MOTION

Model No. : TL7
 Power Rating : DC24V
 Duty cycle : 10% Max 2Min ON/18Min OFF
 Max.Load : Push 800N
 Max.Current : Max.6.0Amp





Part No. 
 TL7-2C-650590-202E4

Serial No. 
 201010110001

TL9

T:MOTION

Model No. : TL9
 Power Rating : DC24V
 Duty cycle : 10% Max 2Min ON/18Min OFF
 Max.Load : Push 800N
 Max.Current : Max.6.0Amp





Part No. 
 TL9-2C-650590-302E4

Serial No. 
 201010110001

TL10

T:MOTION

Model No. : TL10
 Power Rating : DC24V
 Duty cycle : 10% Max 2Min ON/18Min OFF
 Max.Load : Push 800N
 Max.Current : Max.6.0Amp



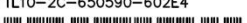

Part No. 
 TL10-2C-650590-602E4

Serial No. 
 201010110001

TL11

T:MOTION

Model No. : TL11
 Power Rating : DC24V
 Duty cycle : 10% Max 2Min ON/18Min OFF
 Max.Load : Push 800N
 Max.Current : Max.6.0Amp





Part No. 
 TL11-2C-650590-702E4

Serial No. 
 201010110001

TL12

T:MOTION

Model No. : TL12
 Power Rating : DC24V
 Duty cycle : 10% Max 2Min ON/18Min OFF
 Max.Load : Push 800N
 Max.Current : Max.6.0Amp



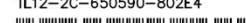

Part No. 
 TL12-2C-650590-802E4

Serial No. 
 201010110001

TL13

T:MOTION

Model No. : TL13
 Power Rating : DC24V
 Duty cycle : 10% Max 2Min ON/18Min OFF
 Max.Load : Push 800N
 Max.Current : Max.5.0Amp



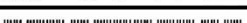

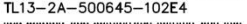
Part No. 
 TL13-2A-500645-102E4

Serial No. 
 201010110001

TL14

T:MOTION

Model No. : TL14
 Power Rating : DC24V
 Duty cycle : 10% Max 2Min ON/18Min OFF
 Max.Load : Push 800N
 Max.Current : Max.5.0Amp





Part No. 
 TL14-2A-500645-302E4

Serial No. 
 201010110001

TL15

T:MOTION

Model No. : TL15
 Power Rating : DC24V
 Duty cycle : 10% Max 2Min ON/18Min OFF
 Max.Load : Push 800N
 Max.Current : Max.5.0Amp

Part No. 
 TL15-2A-500645-702E4

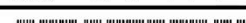
Serial No. 
 201010110001

15. TiMOTION Application Policy

The purpose of the application policy is to define responsibility scope associate with applying a TiMOTION product defined as hardware, software, technical advice, etc. related to an existing or new customer application.

TiMOTION products as defined above are applicable for a wide range of applications. Yet, TiMOTION is not able to know all conditions against different TiMOTION products which will be installed used and operated since each individual application is unique.

The suitability, reliability and functionality of the TiMOTION product and its performance under varying conditions (application, vibration, load, humidity, temperature, frequency, etc.) can only be certified by testing, and shall ultimately be the responsibility of the TiMOTION customer using any TiMOTION product.

TiMOTION shall be responsible solely that the TiMOTION products comply with the specifications set out by TiMOTION and it shall be the responsibility of the TiMOTION customer to ensure that the specific TiMOTION product can be used for the application in question.

16. History

Ver.	Date	Revisions
1	2017/02/18	1 st release
2	2017/06/07	<ul style="list-style-type: none">● Changed the picture of TC15● Revised the error codes: E04, E05, M1● Revised the alerts: E31 & E32● Revised the dimensions
3	2017/10/24	<ul style="list-style-type: none">● Changed the BIFMA code● Changed the speed of single columns● Revised the alerts: E21 / E22 /E31 / E32
4	2017/11/09	<ul style="list-style-type: none">● Minor wording revisions